



// PURO ITALIAN  
**DESIGN**

---

COLLECTION 2018





## // PURO ITALIAN **DESIGN**

A story that has changed the leisure vehicles' world and turned the traditional crafts into design; the Mobilvetta story has paved the way to internationalisation and anticipated the future. To be born in the sixties as furniture manufactures led Mobilvetta to develop a very innovative know how over the years.

A new product philosophy was introduced: the conception of the recreational vehicle not only as a well-equipped product but as a real "travelling home". The artisans skills joining the constant advanced technology systems contribute in reaching high quality standards.





// WHEN THE STYLE  
TURNS INTO  
**DESIGN**



**WHY  
MOBIL  
VENTIA?**



# // Centro Stile Mobilvetta V CONCEPT *V-concept*

We came up with the V-Concept with the desire to highlight all the elements that have always distinguished the Mobilvetta brand. Craftsmanship, design, style and elegance combined beneath the distinctive Mobilvetta V. The V Concept is to be found in the design of the wall units in continuity with the ceiling panels of the modern Yachts, in the armrests of the V-Sofa and in the upstands of the tops for kitchen and bathroom.

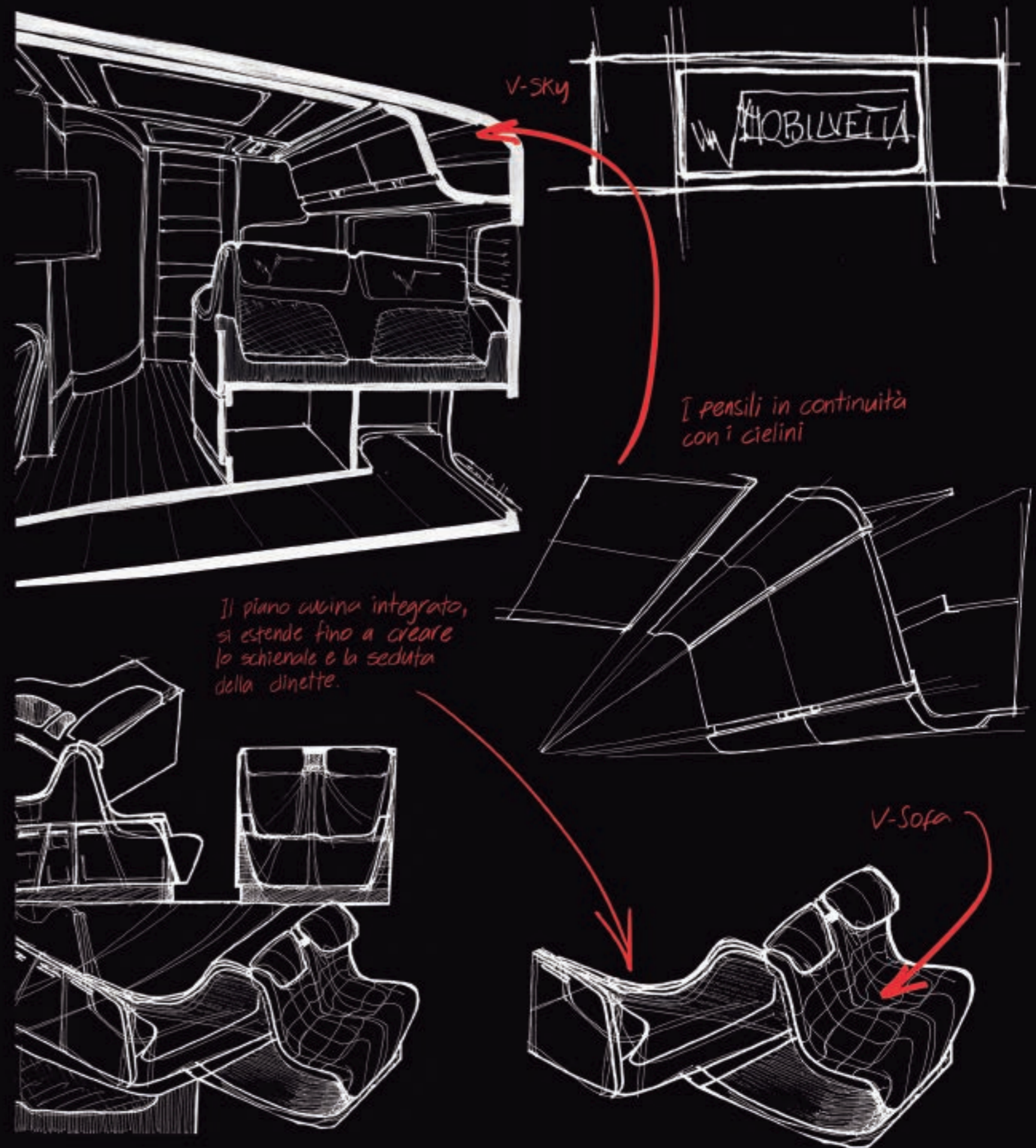



// SPACES DESIGNED  
FOR WELCOME AND  
TO AMAZE  
**FROM CONCEPT**



## TO REALITY

MANY INTERPRETATIONS,  
A SINGLE DESIGN

The K-YACHT TEKNO DESIGN range is here: the new Mobilvetta motorhomes represent the true essence of the brand in all their beauty. An incredible mix of automotive ergonomics and the refined, exclusive quality of the Italian design.



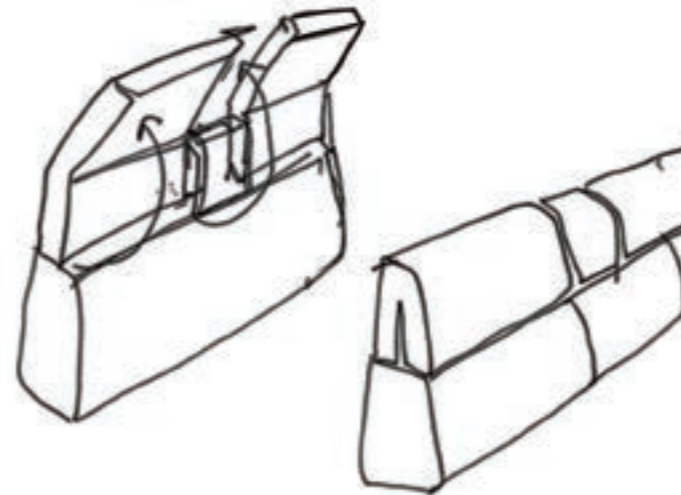
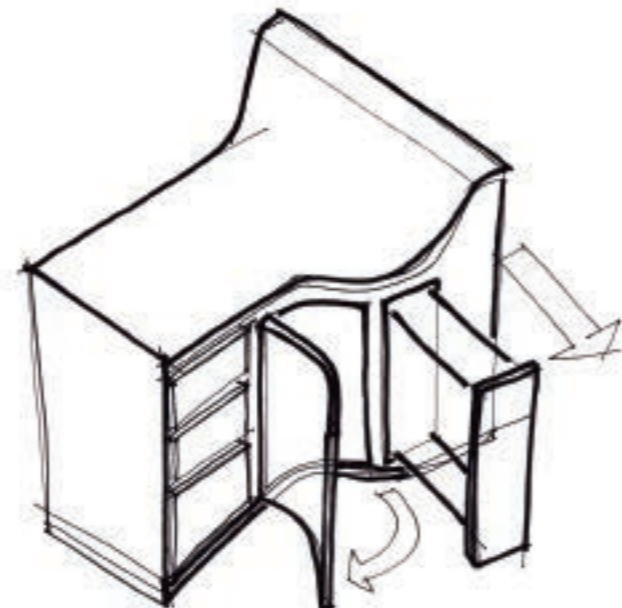
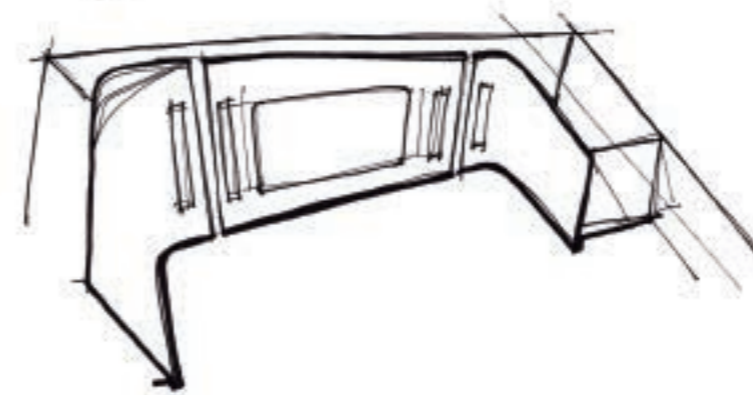
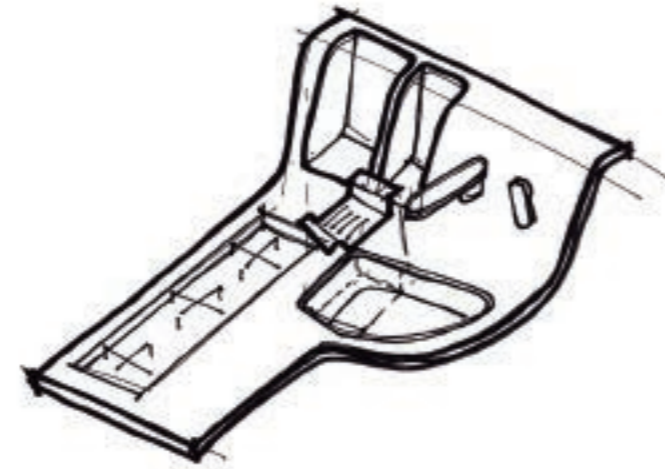
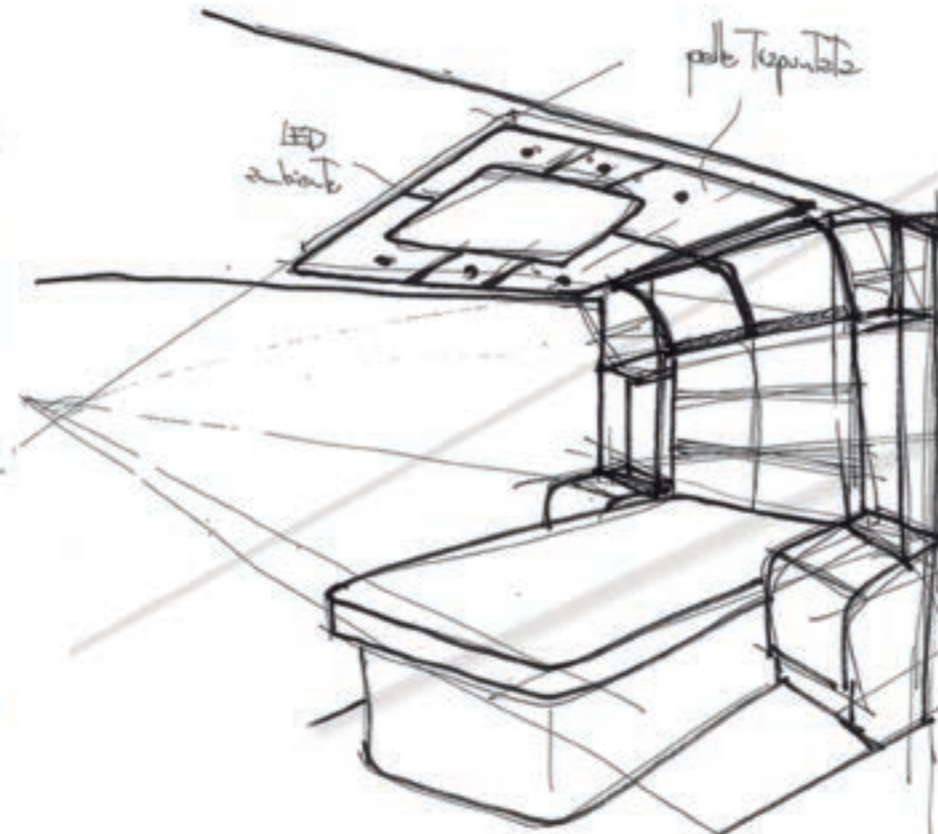
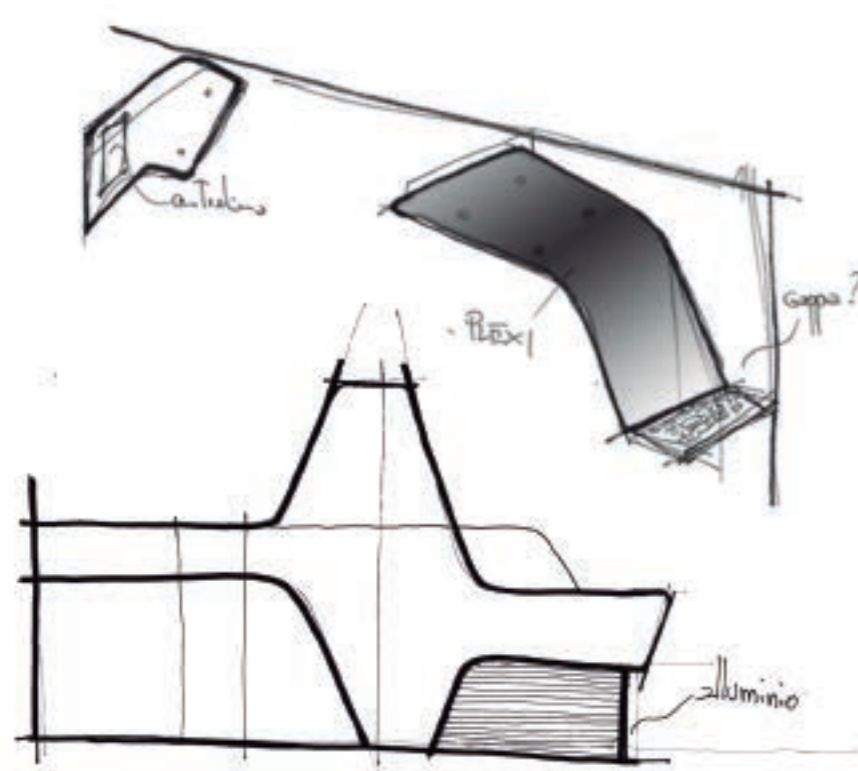

# ELEMENTS OF THE DESIGN

V-concept

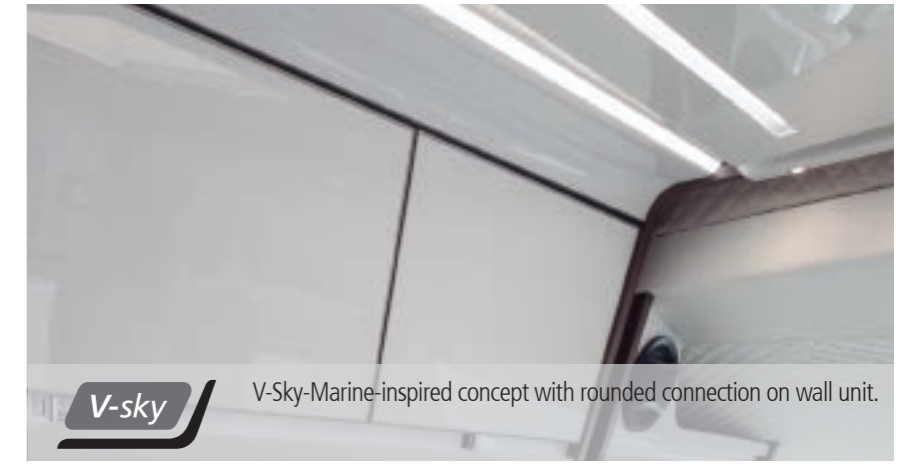
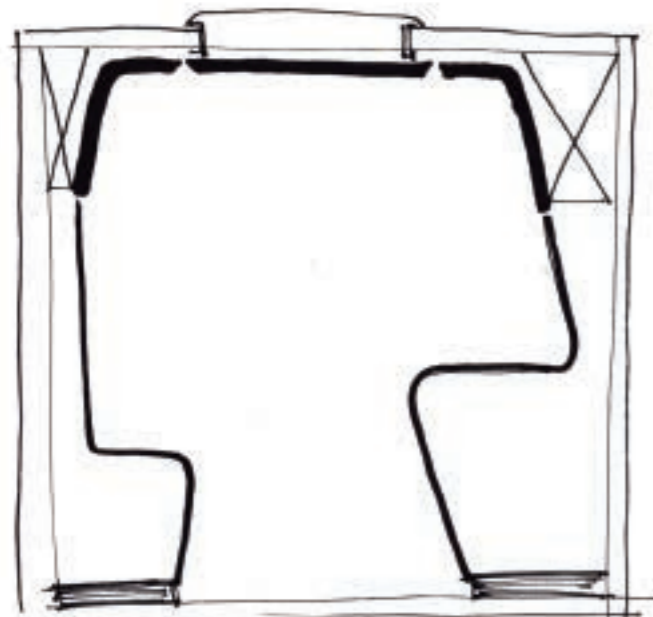

V-sky

V-Sky-Marine-inspired concept with rounded connection on wall unit.



V-top

V-Top-Solid, compact block extending from the hob to the dinette headrests, forming a V.



V-sofa'

V-Sofa-Ergonomic two-seater sofa with V-shaped armrests for the utmost comfort during the journey.



V-bag

V-Bag - Removable shoulder bag with shape recalling the V Concept.



# MATERIALS IN THE DESIGN

Materials with their own spirit and structure, ready to emerge in your emotions.



+ SUBSTANCE AND REASSURING  
**PERFECTION**



Aluminium-Taps  
Aluminium taps made to a design that frees up the space beneath for greater freedom of movement.



Aluminium profile on cupboards  
The aluminium profile inside the door lends greater stability to the structure as a whole.



# MATERIALS IN THE DESIGN



Stainless steel hob  
Long-lasting and highly resistant to corrosion.



Light Stone  
Integrated top shaped into a continuous surface,  
thanks to single-piece forming technology.



# MATERIALS IN THE DESIGN

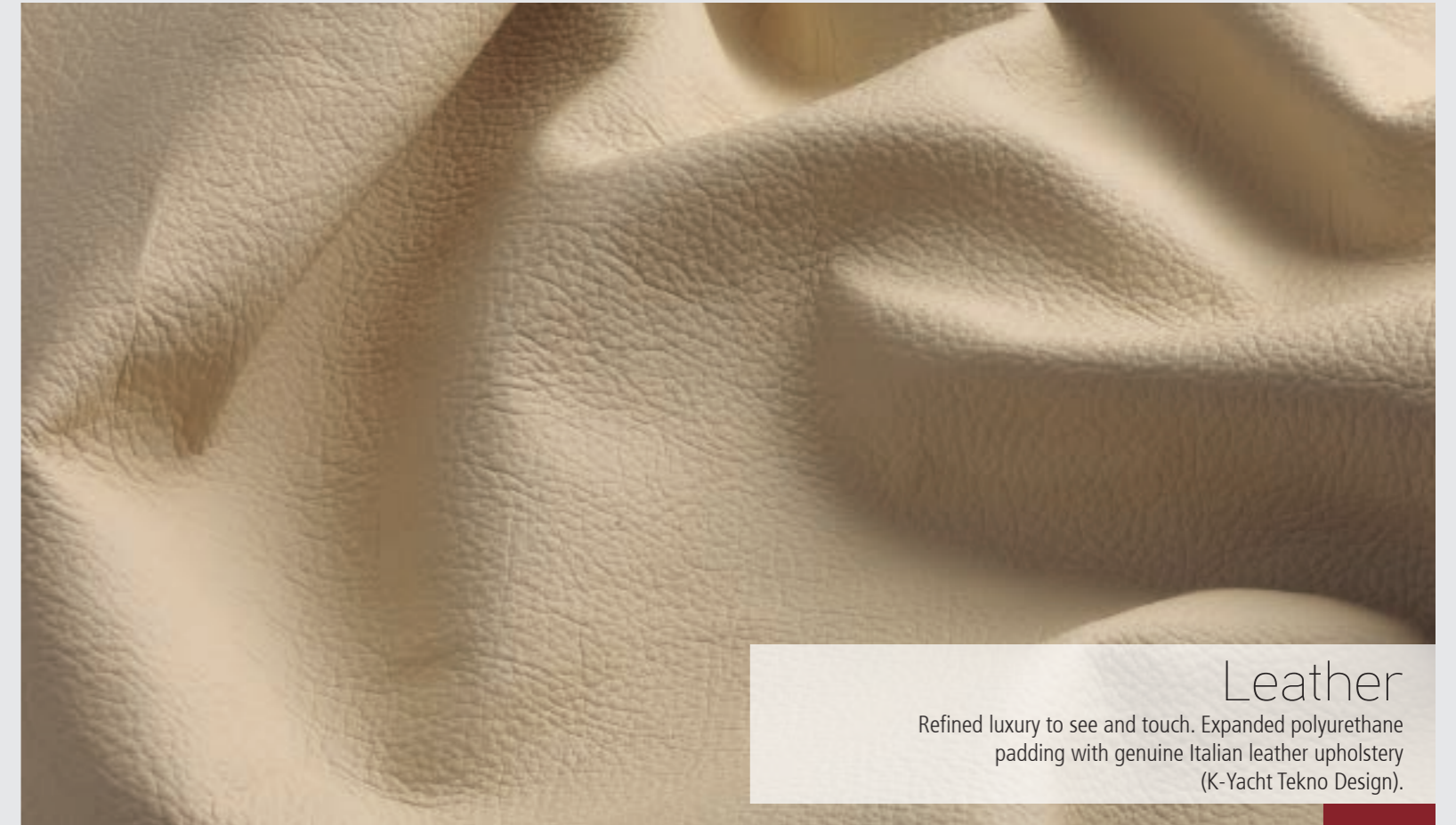

## Leather

Refined luxury to see and touch. Expanded polyurethane padding with genuine Italian leather upholstery (K-Yacht Tekno Design).



## Fabrics

Fabrics with exclusive Mobilvetta design, fine and natural fibres. (K-Yacht Tekno Line - Kea).



// EVOLUTION IN  
MOTORHOME



Concept by Centro Stile Mobilvetta





// FOUR DIFFERENT STYLES  
FOR EXPERIENCING  
**DESIGN**

**K.yacht**  
TEKNO DESIGN

Bewitching rationality



**Kea**

Enchanting versatility



**K.yacht**  
Tekno Line

Seductive practicality



**K.Silver i**

Appealing functionality





# THE TEKNO DESIGN DAY AREA

## // Concept

We started with the idea of bringing a genuine home sofa into the leisure vehicle as a development to the conventional L-shaped dinette: we designed an ergonomic two-seater sofa with armrests for the utmost comfort when travelling and relaxing.

## // Multifunction

The table with book-type opening, which can be moved and rotated 360°, permits maximum functionality in supporting for various activities, from reading a magazine to a comfortable meal for several people.

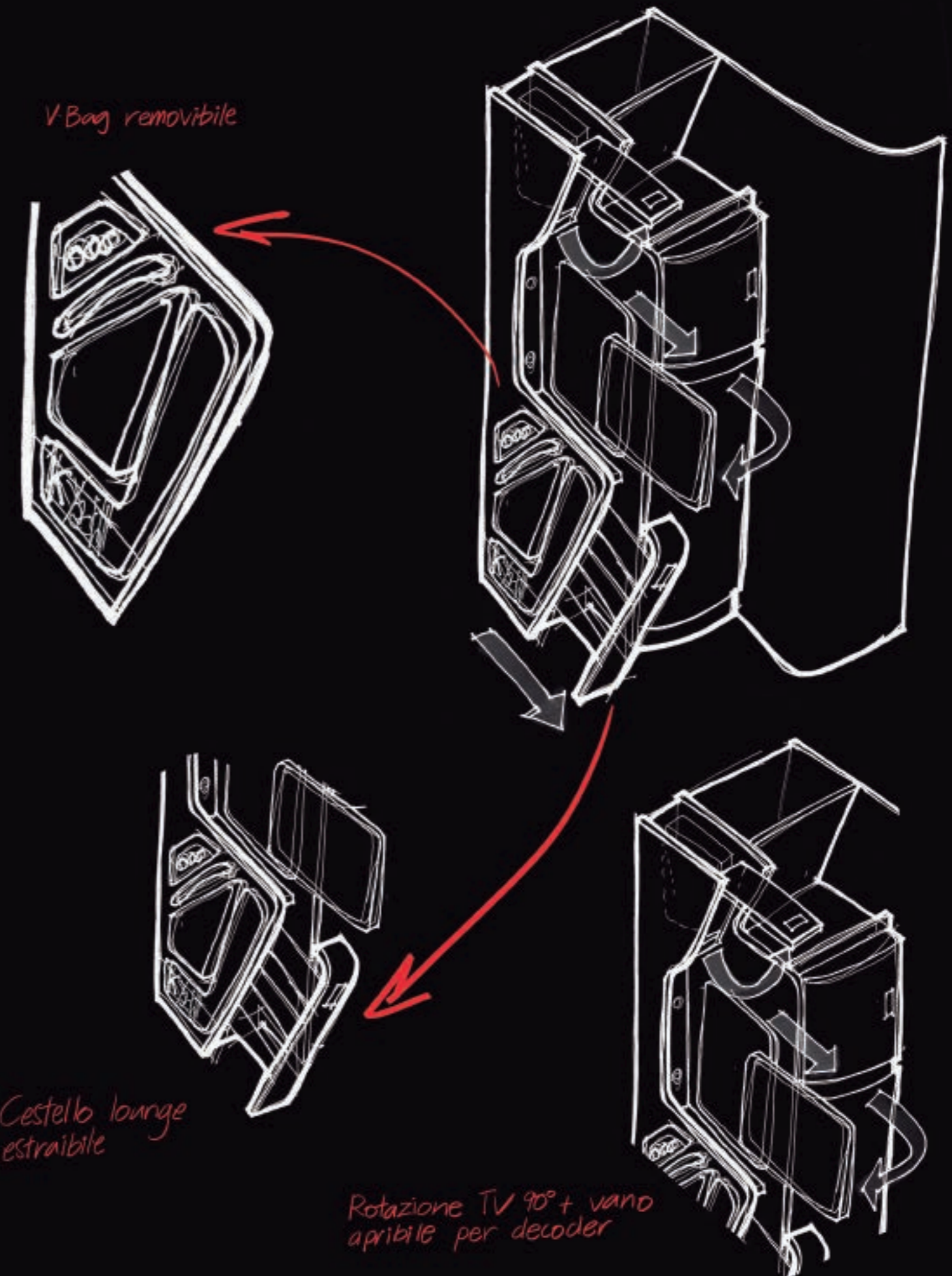



# THE DAY

// AREA



## AS COMFY AND WELCOMING AS YOUR HOME

+ 180° swivel cabin seats  
matching with living area  
upholstery  
(K-Yacht Tekno Design and K-Silver i)

- High quality upholstery materials
- Comfortable side sofa with fifth place as option (when foreseen)
- Large internal dimensions and greater comfort thanks to the movement mechanism of the drop-down bed, which doesn't take up the social space of the dinette even when open.



// BEWITCHING  
**RATIONALITY**



**+** YOU CAN ADAPT  
YOUR TABLE  
**TO YOUR**  
TRAVEL REQUIREMENTS

**THE DAY**  
// AREA

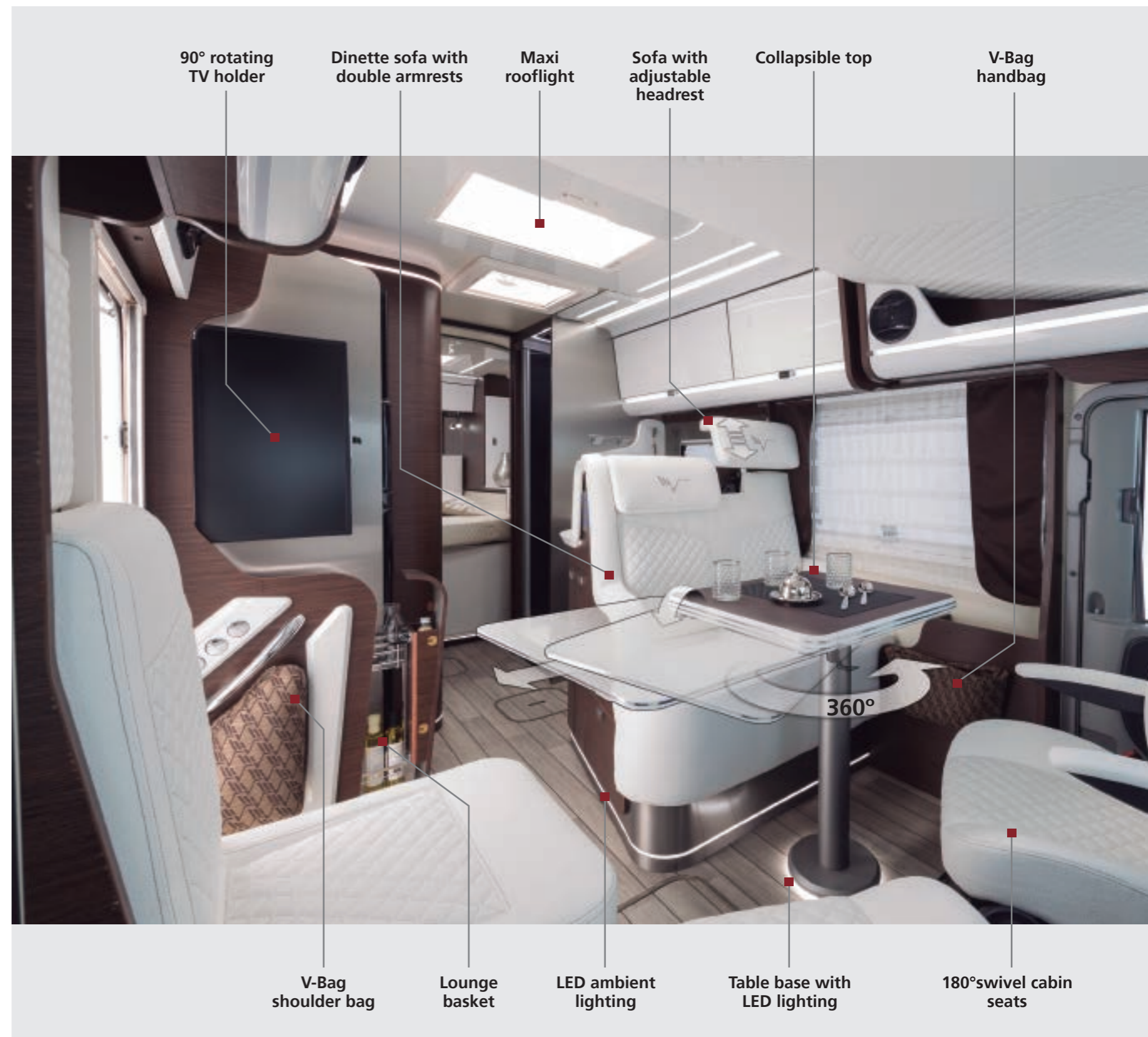



// SEDUCTIVE  
**PRACTICALITY**



**THE DAY**  
// AREA



Large storage compartments

Rotating TV holder

Sofa with adjustable headrest

Maxi rooflight

Usb input

Double-density expanded polyurethane seats

Brightness regulator

Storage compartment

Equipped sliding column

Dinette base with fabric upholstery

Table with 360° rotation system

Ergonomic seats with double armrests and integrated belt



# // ENCHANTING VERSATILITY



# THE DAY // AREA

Kea





// APPEALING  
**FUNCTIONALITY**



**+** YOU'LL NEVER HAVE  
TRAVELLED IN  
**SUCH COMFORT**

**THE DAY**  
// AREA

*K. Silver i*

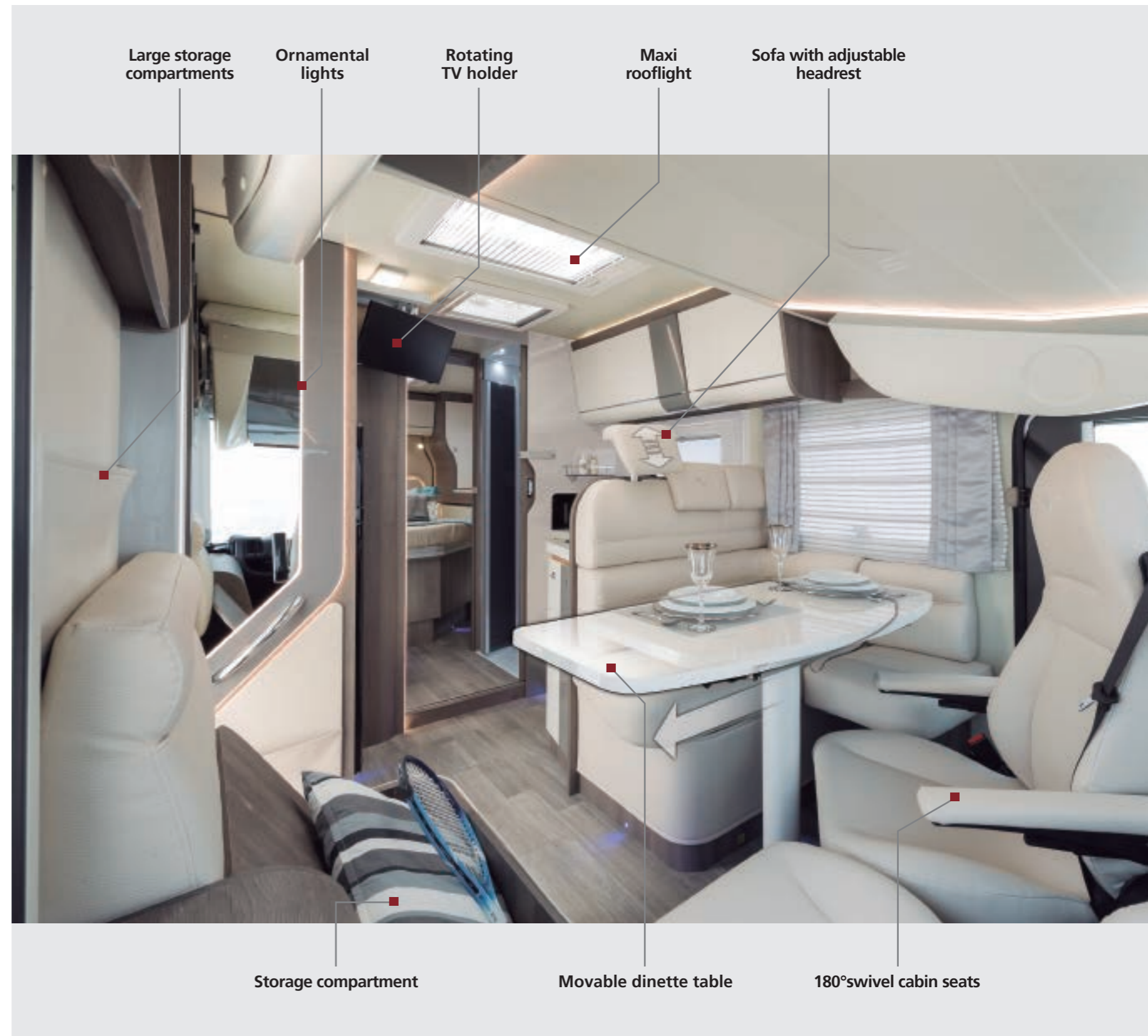

Large storage  
compartments

Ornamental  
lights

Rotating  
TV holder

Maxi  
rooflight

Sofa with adjustable  
headrest

Storage compartment

Movable dinette table

180°swivel cabin seats



# THE TEKNO DESIGN KITCHEN AREA

## // Concept

We worked the V Concept into the spaces of the kitchen, shaping the top into a continuous surface which, thanks to the LIGHT STONE single-piece forming technology, allowed us to extend it to create the back and seat of the dinette

## // Multifunction

Studying the design for the worktop allowed us to create a maxi sink equipped with two flush covers: the larger one can be turned over for use as a cutting board, and the smaller as an additional top to fix to the wall, while together they create a large support surface. The shaped stainless steel utensil holder becomes a handy drip tray to insert in the sink for food preparation.

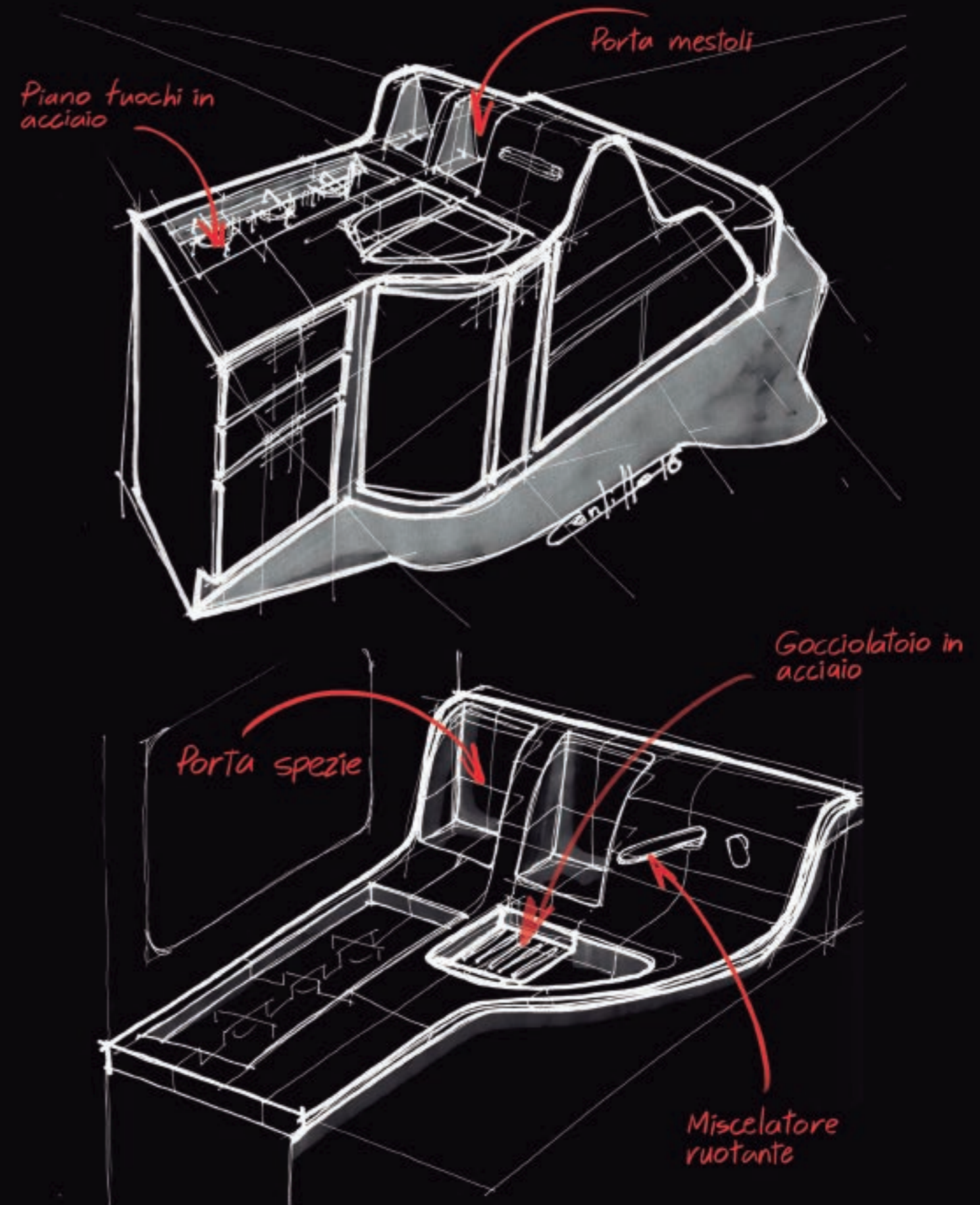



# THE KITCHEN

// AREA



## // THE TASTE OF HOME

Exclusive choices for an environment expressing the pure Italian style: elegance and functionality mixing together for a modern and innovative space.



// BEWITCHING  
**RATIONALITY**



YOU CAN CONFIGURE THE KITCHEN  
**AS YOU WISH**  
+ SUPPORT BASE ALWAYS  
AVAILABLE

**THE KITCHEN**  
// AREA

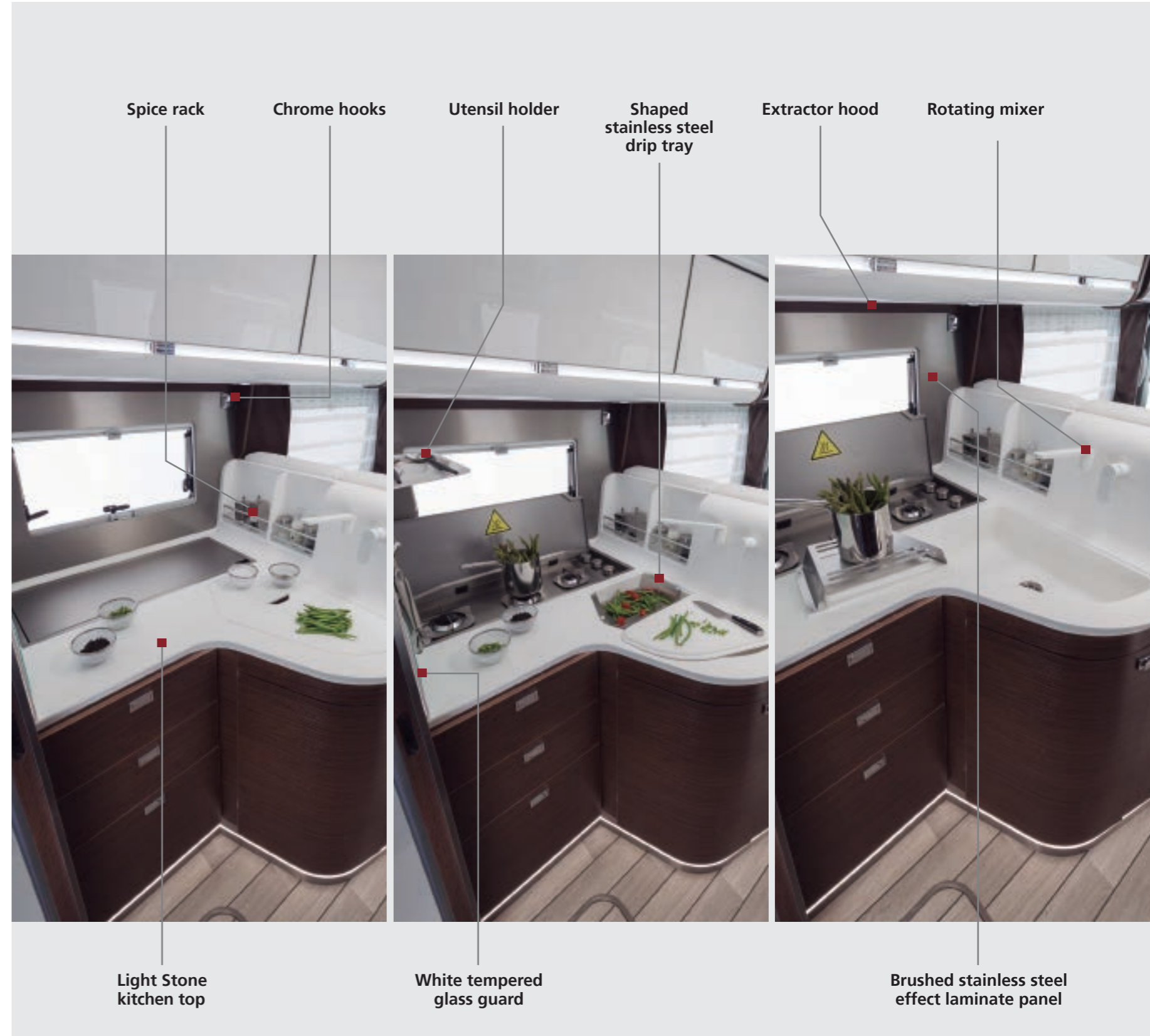

Spice rack

Chrome hooks

Utensil holder

Shaped stainless steel drip tray

Extractor hood

Rotating mixer

Light Stone kitchen top

White tempered glass guard

Brushed stainless steel effect laminate panel



// ENCHANTING  
**VERSATILITY**



**+** EVERYTHING IN THIS KITCHEN  
IS DESIGNED TO  
**OPTIMISE SPACE**

# THE KITCHEN

// AREA

*K.Yacht*  
TEKNO DESIGN

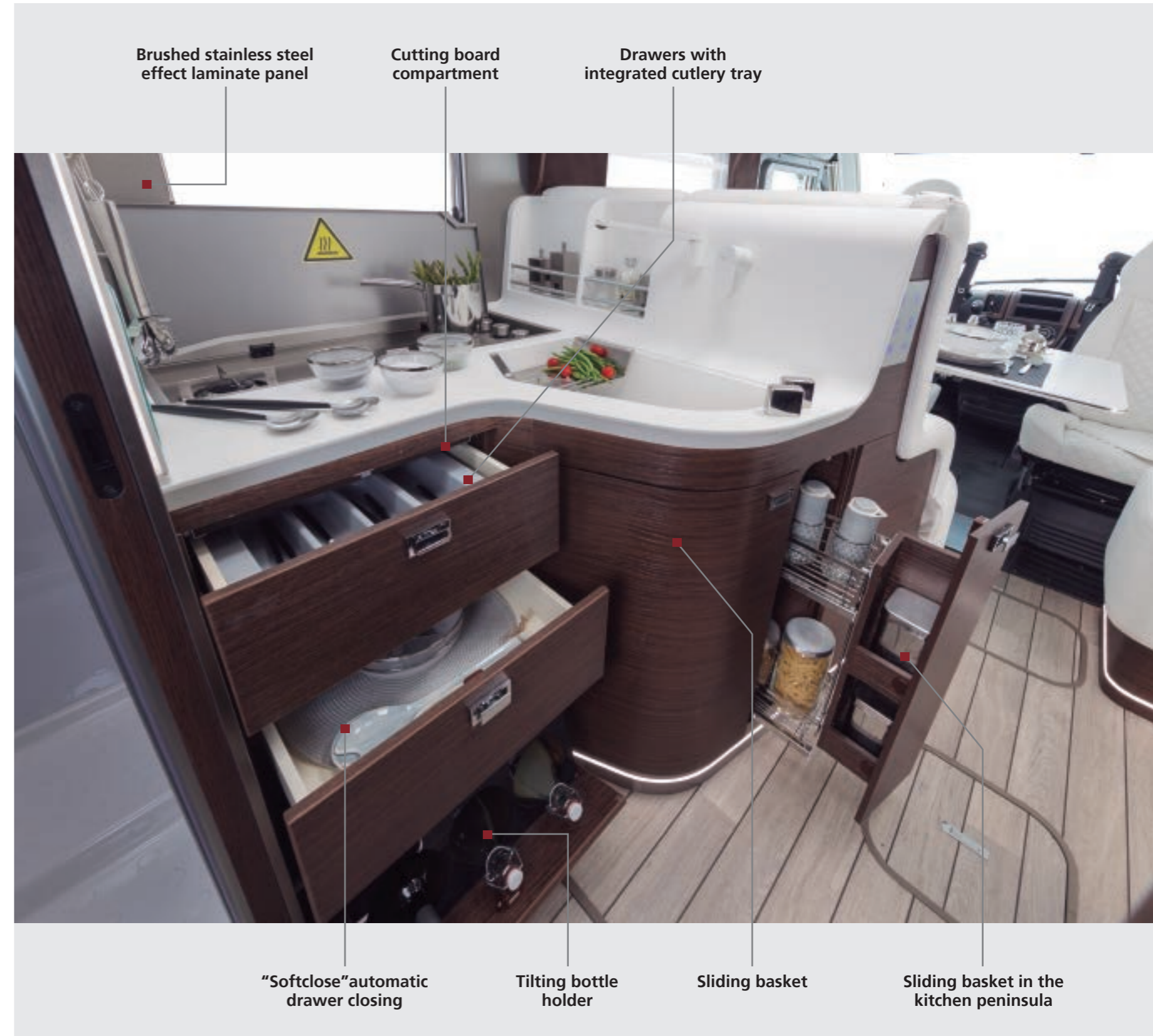

Brushed stainless steel  
effect laminate panel

Cutting board  
compartment

Drawers with  
integrated cutlery tray

"Softclose" automatic  
drawer closing

Tilting bottle  
holder

Sliding basket

Sliding basket in the  
kitchen peninsula



// SEDUCTIVE  
**PRACTICALITY**

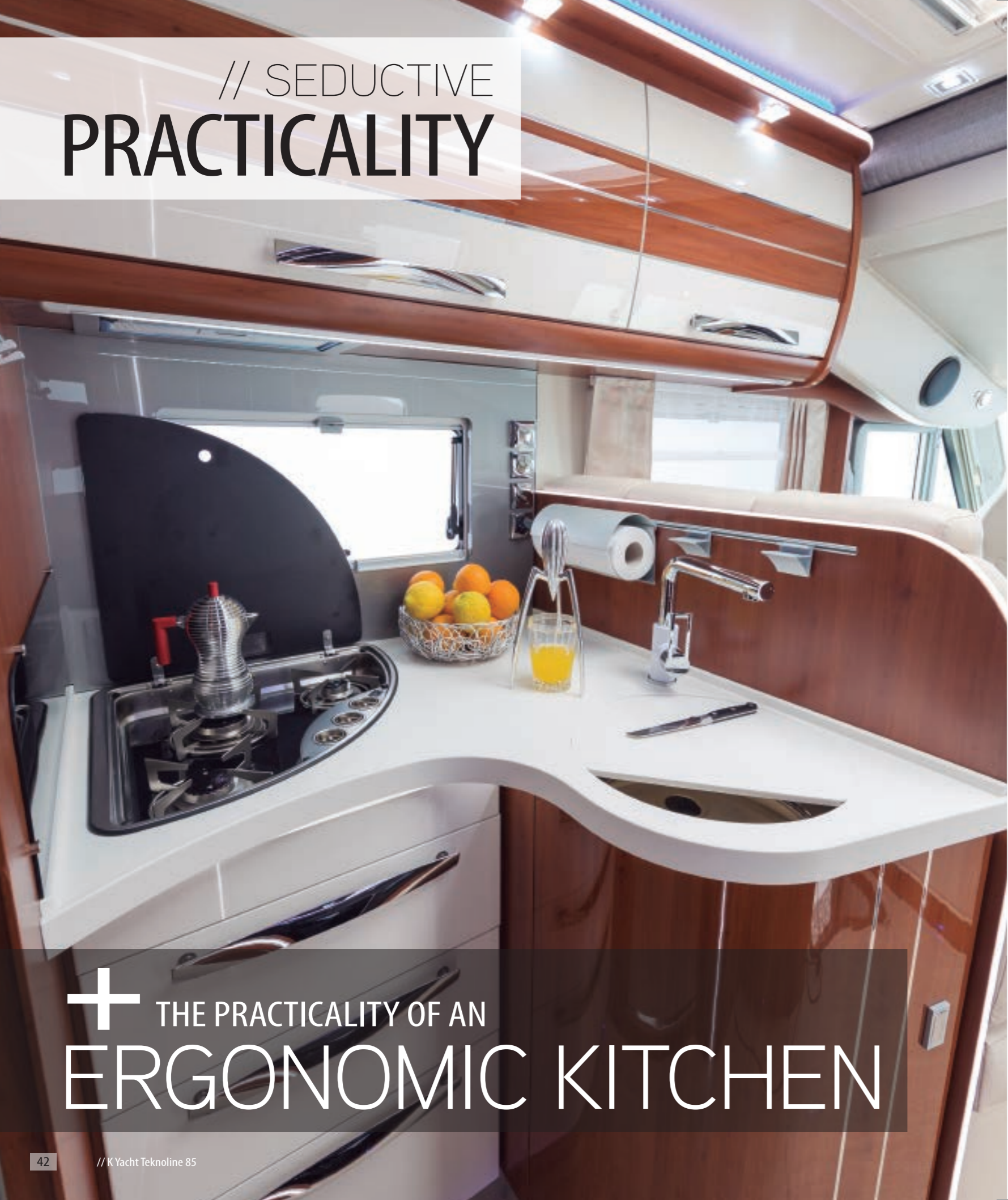

**+** THE PRACTICALITY OF AN  
**ERGONOMIC KITCHEN**

# THE KITCHEN

// AREA

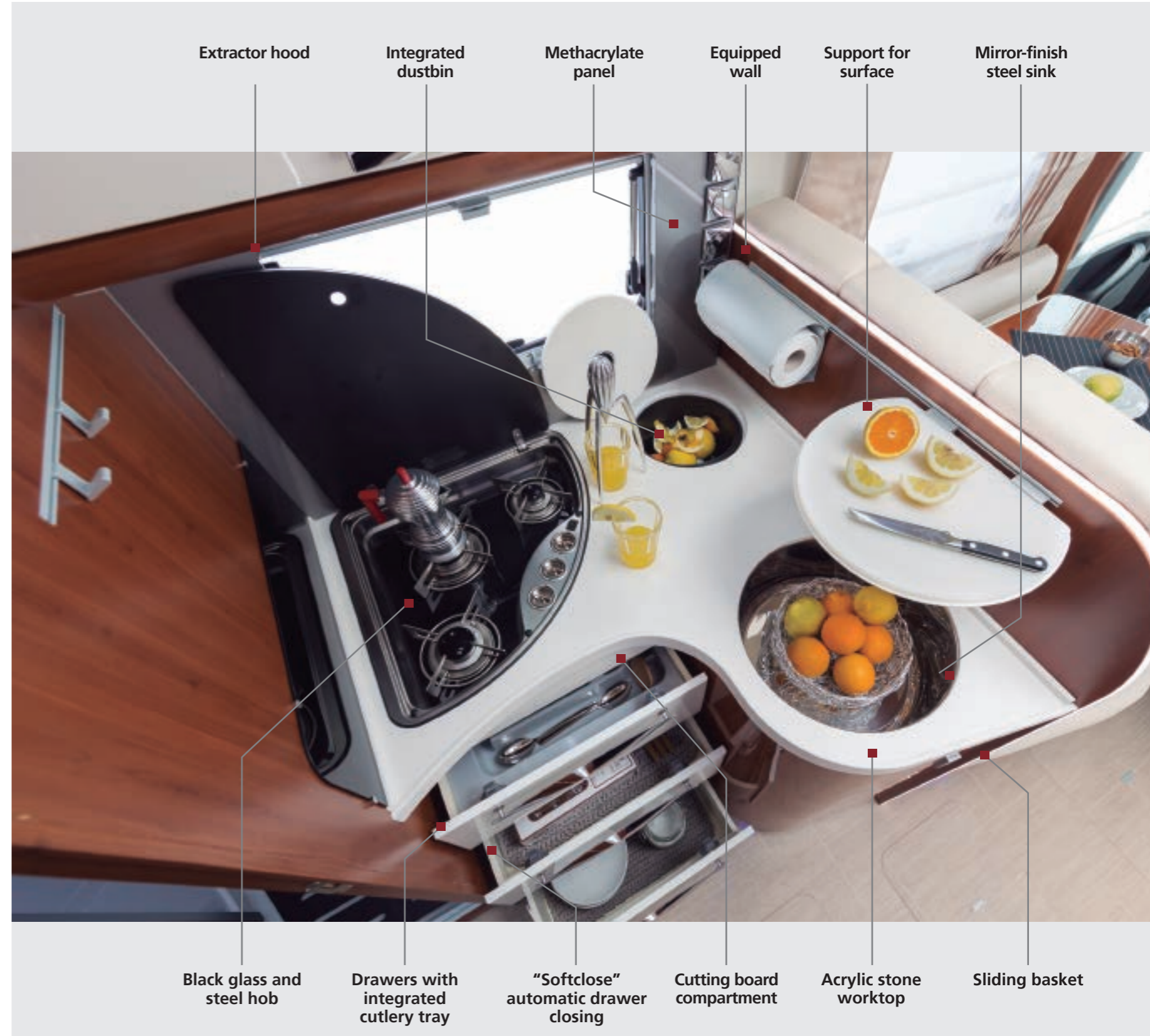







# // ENCHANTING VERSATILITY

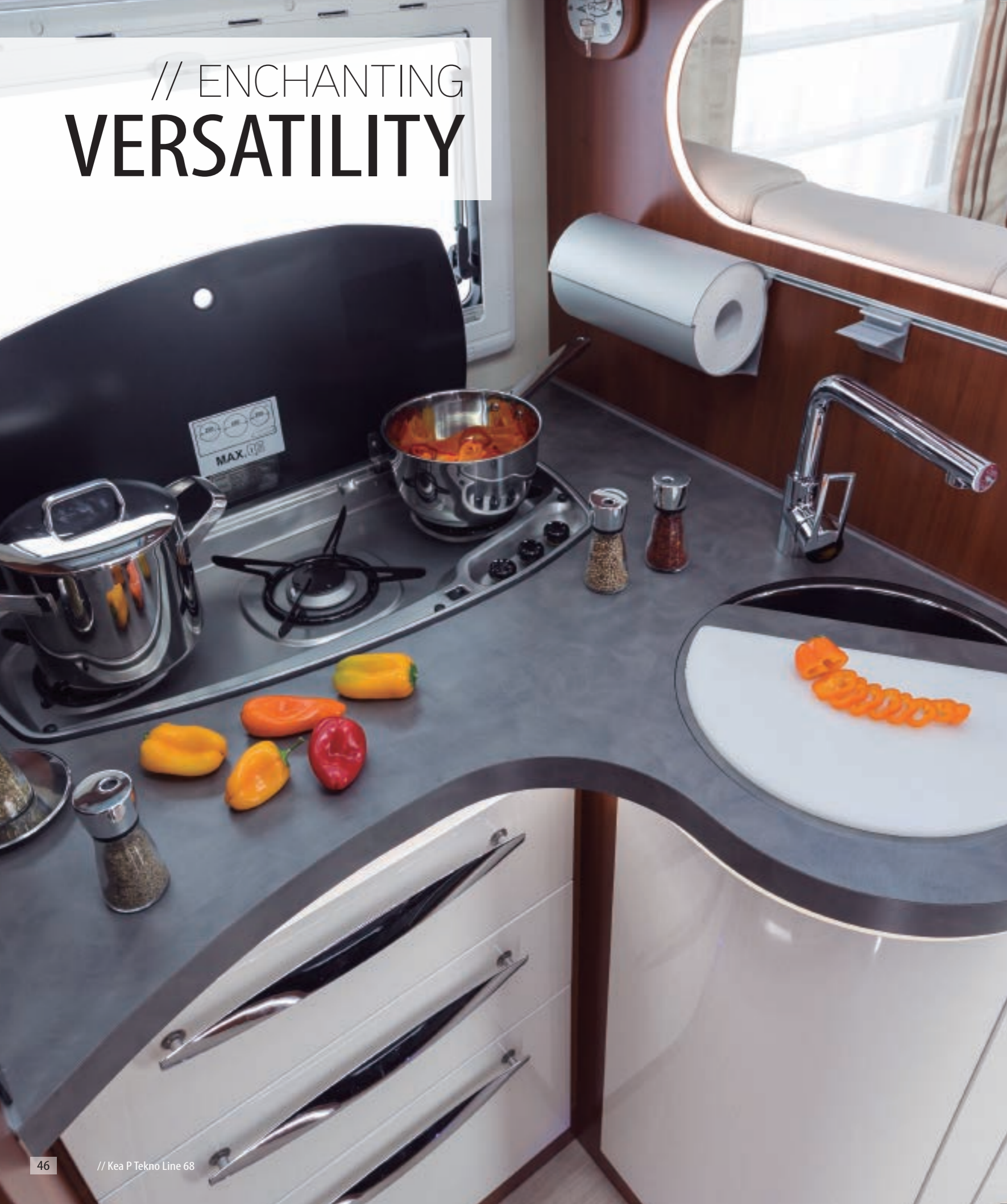

# THE KITCHEN // AREA

Kea

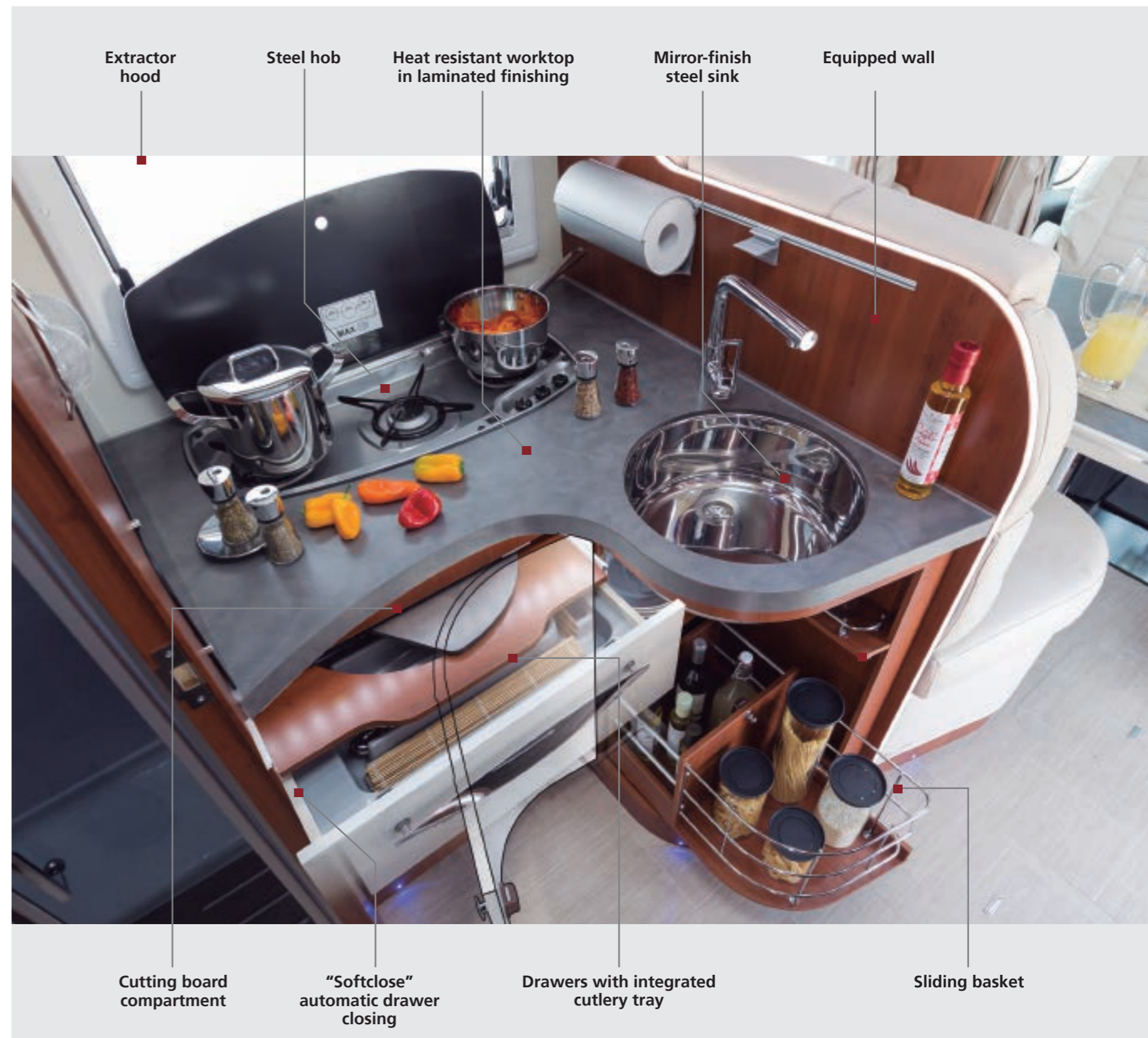



# // APPEALING FUNCTIONALITY



# THE KITCHEN // AREA

*K. Silver i*

"Softclose" automatic  
drawer closing

Support for  
surface

Spice basket

Sliding basket in the  
kitchen peninsula



Drawers with integrated  
cutlery tray

Heat resistant worktop  
in laminated finishing

Kitchen peninsula equipped  
with double shelf



# THE TEKNO DESIGN NIGHT AREA

## // Concept

Enveloping, welcoming space for resting. Marine ceiling panel in continuity with the wall units and headboards

## // Multifunction

The surfaces of the bedside tables and base of the bed are covered in eco leather to ensure maximum comfort when moving around at night.

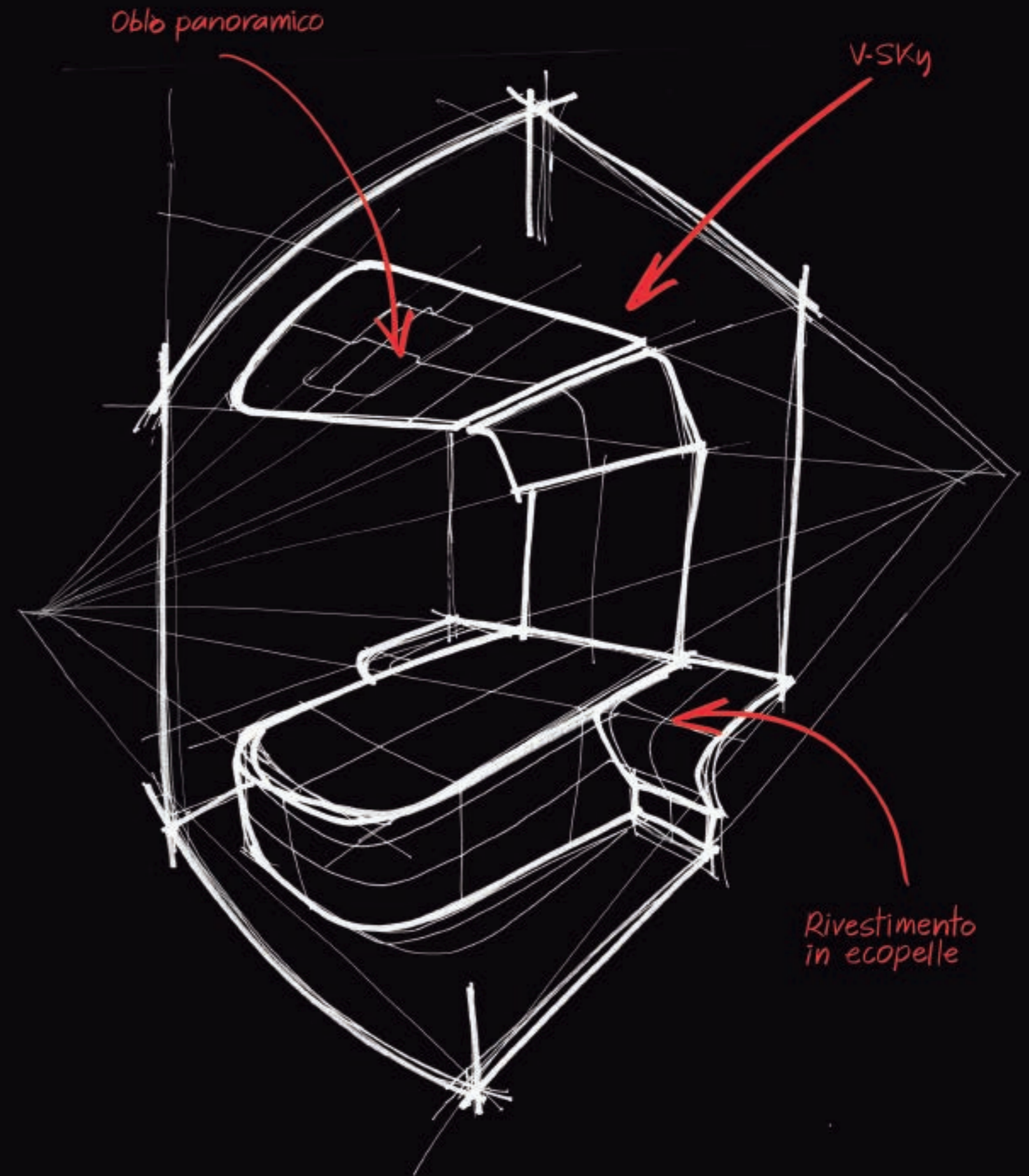



# THE NIGHT

// AREA







- +
- Greater comfort when sleeping
- Anti-mite treatment
- Washable
- Removable covers
- Mobilvetta mattresses and slatted bases





# // BEWITCHING RATIONALITY



# THE NIGHT // AREA





// SEDUCTIVE  
**PRACTICALITY**



**THE NIGHT**  
// AREA





// ENCHANTING  
**VERSATILITY**



**THE NIGHT**  
// AREA



Padded  
headboards

LED ambient  
light

Panoramic rooflight  
with fly screen  
and blind

Spot lights

wardrobe  
with lighting

TV cable and power  
socket pre-setting

Large container  
under the bed

Step storage areas



# // APPEALING FUNCTIONALITY



# THE NIGHT // AREA

*K Silver i*









# THE TEKNO DESIGN TOILETTE AREA

## // Concept

We worked the V Concept into the toilette area, making the top out of LIGHT STONE: the sink, toothbrush holder and liquid soap dispenser are integrated with its sinuous profile.

## // Multifunction

The wall-mounted mixer can be rotated to free up space for accessing the sink. We also created a heated vertical compartment with pull-out towel holder from the top's upstand.

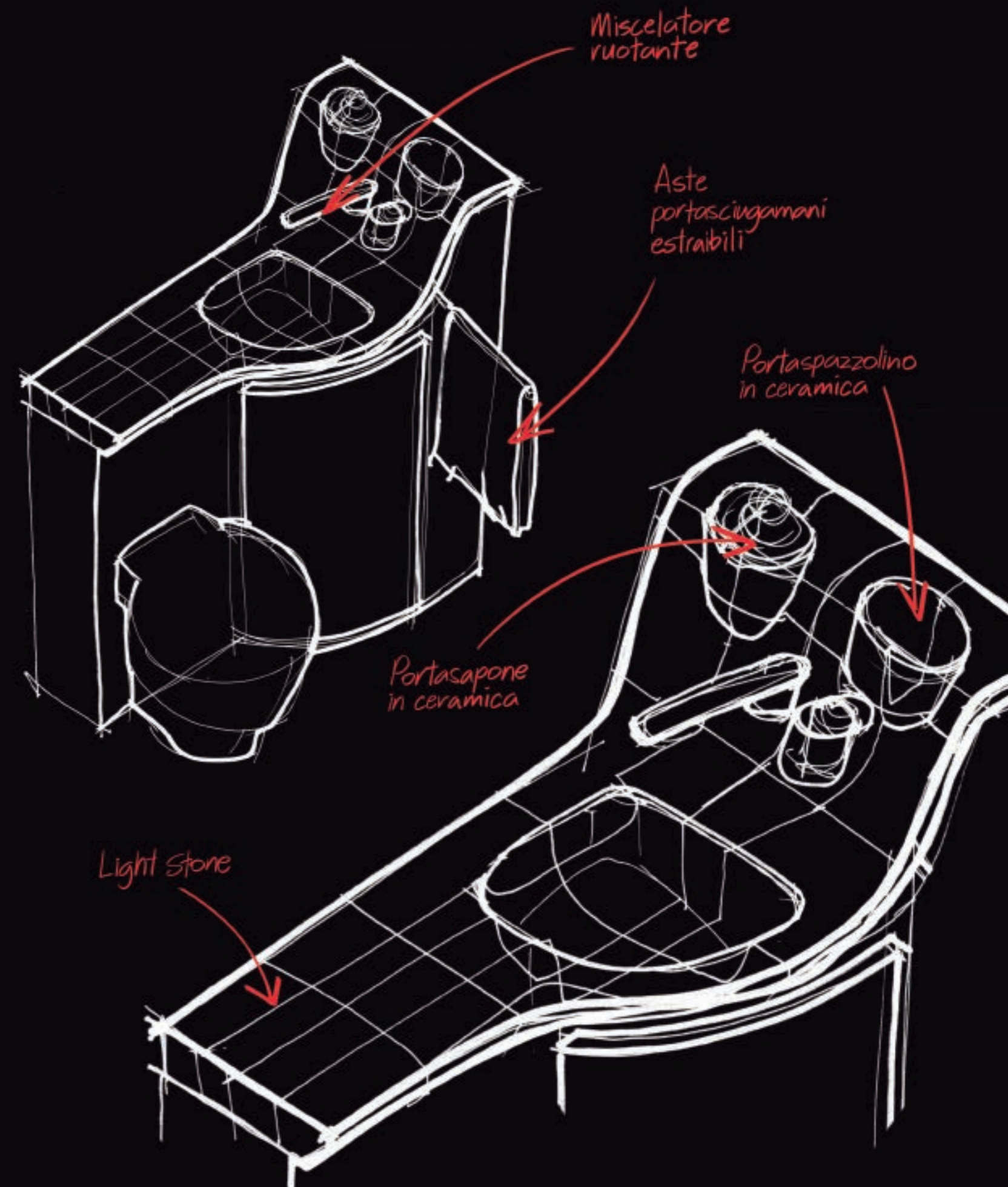



# THE TOILETTE

// AREA



## // SHEER COMFORT

- Convenient steel shelves
- Led lighting 100%
- Complete toilette fittings
- Light ensured by large window



# // BEWITCHING RATIONALITY



# THE TOILETTE

## // AREA





// SEDUCTIVE  
**PRACTICALITY**



# THE TOILETTE

// AREA



Large window

Ceramic toothbrush holder

Ceramic soap holder

Acrylic stone top

Holder under the sink top

Mirror-finish steel sink



# // ENCHANTING VERSATILITY



# THE TOILETTE // AREA



Large window

Ceramic toothbrush holder

Ceramic soap holder

Holder under the sink top

Mirror-finish steel sink

Scratch-resistant laminate top



# // APPEALING FUNCTIONALITY



# THE TOILETTE // AREA

*K-Silver i*





# MOBILVETTA

// LIGHTING



## // 100% LED

European leadership for interior & exterior LED lighting: innovative solutions at low consumption. Standard daytime lights in every model. Additional lights on the ceiling and in several other spots inside the vehicle. Dimmer for self-regulation of the light intensity.



# // BEWITCHING RATIONALITY



# MOBILVETTA // LIGHTING



Night light markers at base of rear bed

LED lighting on kitchen panel

Diffused light from ceiling

Courtesy lights above wall units



Backlit handle

V-Light, smart lighting adjustment

Courtesy light

LED light at base of the table



# // BEWITCHING RATIONALITY



# MOBILVETTA // LIGHTING



Brightness regulator

LED lighting on the column

LED lighting on kitchen panel

Courtesy lights above wall units



Backlit handle

Night light markers at base of rear bed

Night light marks



// ENCHANTING  
**VERSATILITY**



**MOBILVETTA**  
// LIGHTING



Brightness  
regulator

Blue courtesy light  
(Night Light)

Courtesy lights  
above wall units



Backlit handle

Night light marks



// APPEALING  
**FUNCTIONALITY**



**MOBILVETTA**  
// LIGHTING

*K. Silver i*





// UP TO  
**+ 50.000**  
 ABRASION CYCLES

// THE ELEGANCE OF  
 ITALIAN FABRIC

The fabric selection is an important detail in the Mobilvetta interior design. The Company is constantly searching for high-quality and functional fabric to match any kind of need. The materials of the seating, the curtains, the headboards and storage pockets are matching with each other, enhancing the elegance and the pure Italian design. All selected fabrics are easy to wash, stain resistant and with anti-mite treatment. The comfortable padding is in polyurethane foam and non-deformable.

# MOBILVETTA

// FABRIC VARIANTS

*K. Yacht*  
 TEKNO DESIGN

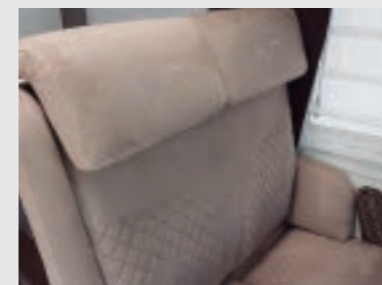

GLAMOUR // Microfibre



SUPREME // Eco leather



PRESTIGE // Eco leather



EXCELSIOR // Real leather

*K. Yacht*  
 Tekno Line

*Kea*



MOBY // Fabric combined with eco leather

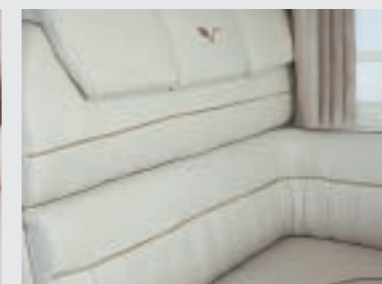

PRESTIGE // Eco leather



COMFORT GREY // Eco leather



MADRAS // Real leather

*K. Silver i*

*K. Silver*



PRESTIGE // Eco leather



COMFORT GREY // Eco leather

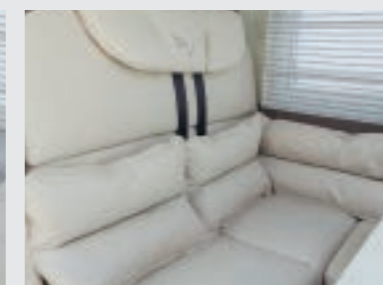

PRESTIGE // Eco leather



COMFORT GREY // Eco leather



// DESIGNED FOR LIVING  
OUT YOUR WINTERS IN

# COMPLETE COMFORT



## // FLOOR HEATING

Floor heating with self-regulating polymeric heating cables.\* Heat spread over the whole area.

- Energy efficiency and costs saving
- No risk of overheating
- Automatically adapted heat emission (OPT KEA M, KEA P, K-Silver / STD K-Yacht Tekno Line and K-Yacht Tekno Design).



(\* By heated folie on K-Yacht Tekno Design.



### CP PLUS

Central heating system control board Boost function for both a fast water and environment heating. Timer Heat regulator.

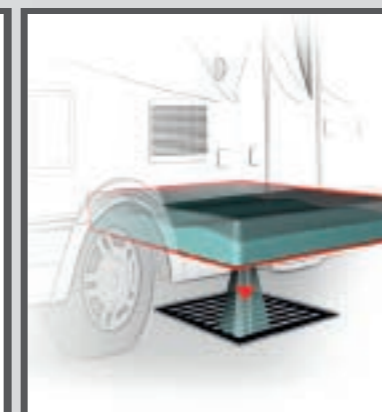

### WINTER PACK

Waste water tank coated with 20 mm insulating material and with anti-freezing resistor (KEAP, KEA M, K-Yacht Tekno Line and K-Silver).



### THE WINDSHIELD

Windshield with double function: defroster in winter season and solar heat protection during the summer (OPT K-Yacht Tekno Line and K-Yacht Tekno Design).



### DASHBOARD / WINDSHIELD PROTECTION

Greater windshield protection against cold/heat. Greater protection against cold draughts inside the passenger compartment. (OPT).



# // THE BODY STRUCTURE



- Waterproofing
- Heat insulation
- Stability
- Easy maintenance
- High mechanical strength
- Lighter walls
- Better soundproofing

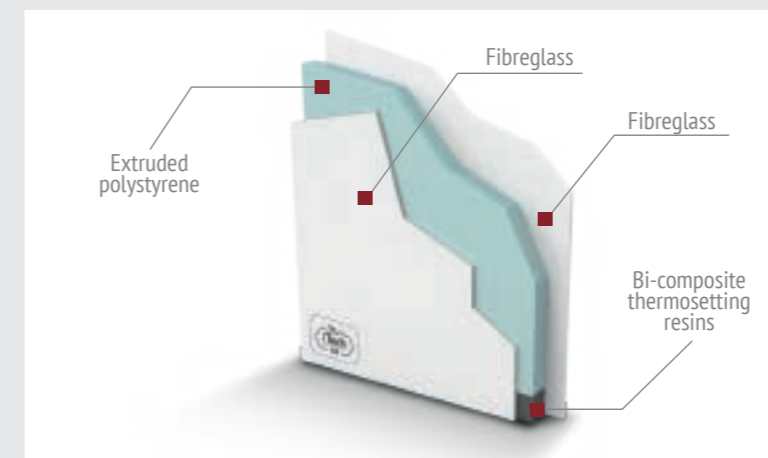

## // Side, rear walls & roof

Wood-free supporting frame made of newly designed plastic resins. Fibreglass underbody coupled with non-slip PVC highly resistant to abrasion. Lighter structure and higher mechanical strength than the traditional wooden panels. Elimination of thermal bridges generated by the wood with higher heat insulation. Easy maintenance. Frame assembly with sound-absorbing materials for a better soundproofing.

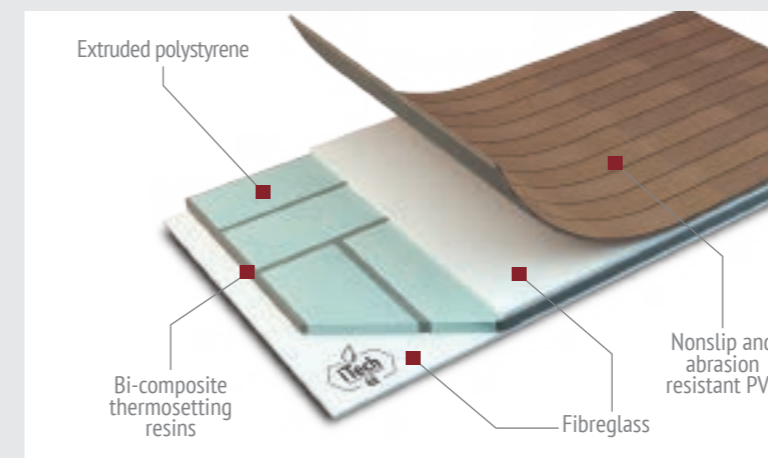

## // The floor structure

Wood-free supporting frame. Exclusive design profiles with high strength thermosetting resin composites. Exterior and interior fibreglass coating. Waterproofing, elimination of thermal bridges generated by the wood. Structure made of extruded materials with higher heat insulation. Industrial type assembly to ensure high quality standards.

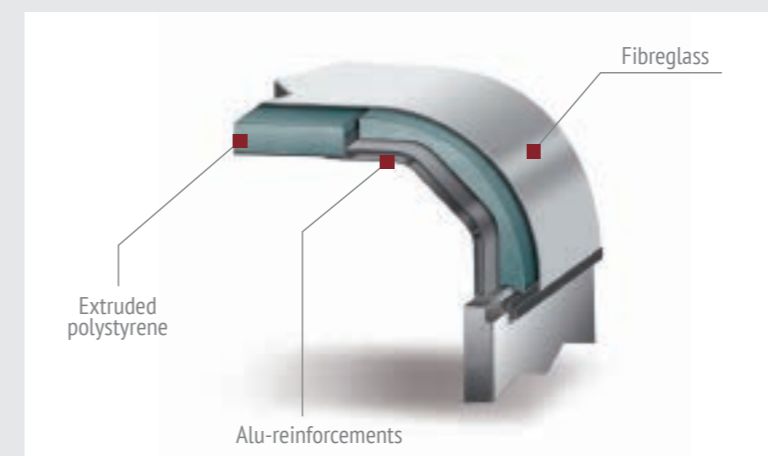

## // Connection roof / wall

Reinforced aluminum profiles, with 160 mm radius. High strength to the structure. Higher heat isolation and stability. Only for Kea P, K-Yacht Tekno Design and K-Yacht Tekno Line range foreseen.



# MOBILVETTA

// STORAGE





# // THE STORAGE COMPARTMENTS ON CHASSIS CAB VERSIONS

*K Silver*



*Kea M*

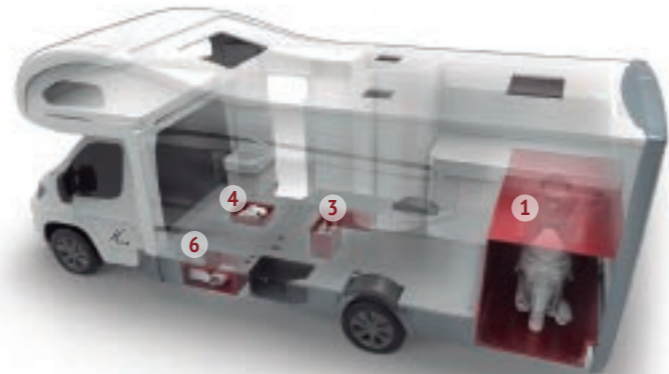

*Kea P*  
Tokio Line

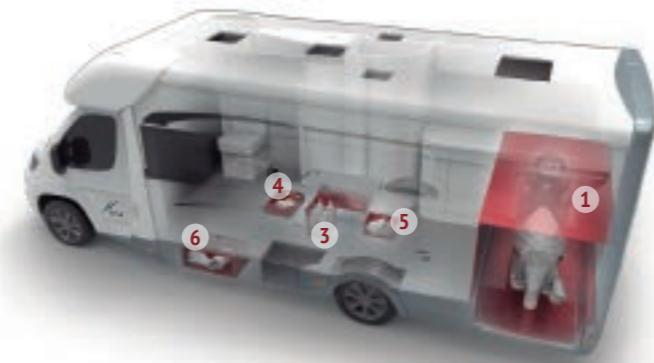

1 Locker with load platform flush with no step. Garage with lighting.



2 Large storage drawers.



3 There are practical storage and bottle compartments in the surface of the floor.



4 Functional storage compartment.



5 Rear storage hatch.



6 External storage integrated on the sideskirts.



# // THE STORAGE COMPARTMENTS ON CHASSIS MOTORHOME

*K. Silver i*

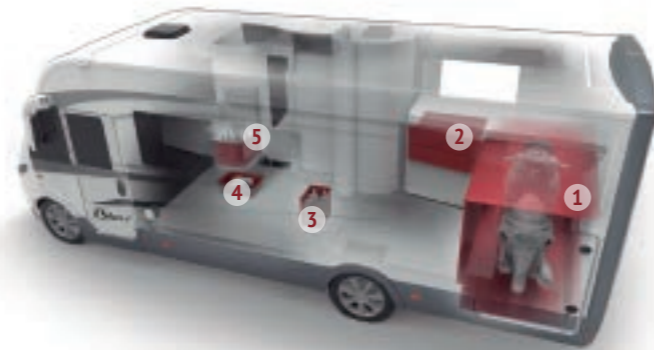

*K. Yacht*  
Tekno Line

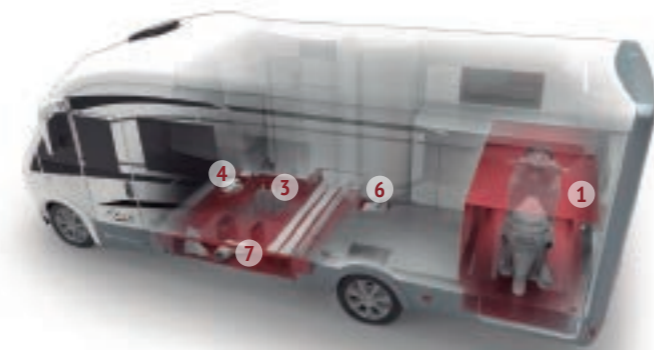

*K. Yacht*  
TEKNO DESIGN

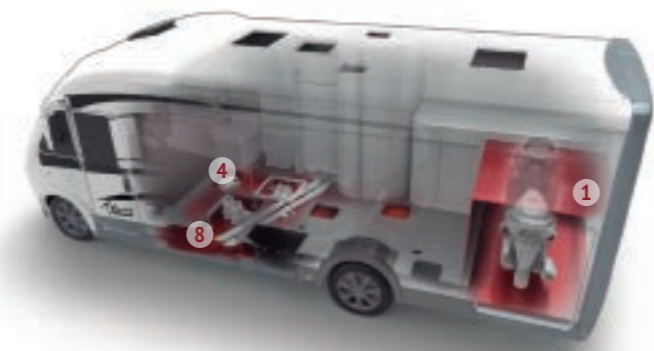

1 Locker with load platform flush with no step. Garage with lighting.



2 Large storage drawers.



3 There are practical storage and bottle compartments in the surface of the floor.

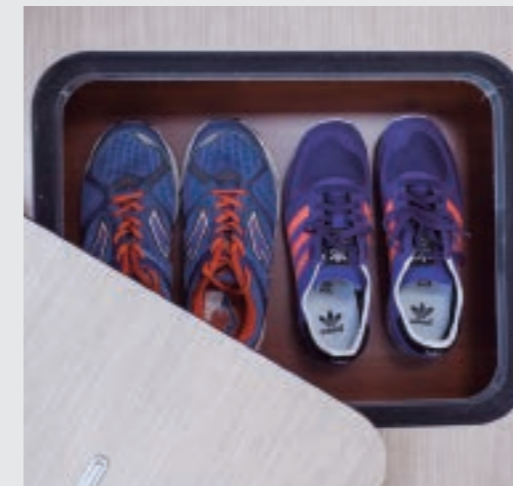

4 Functional storage compartment.

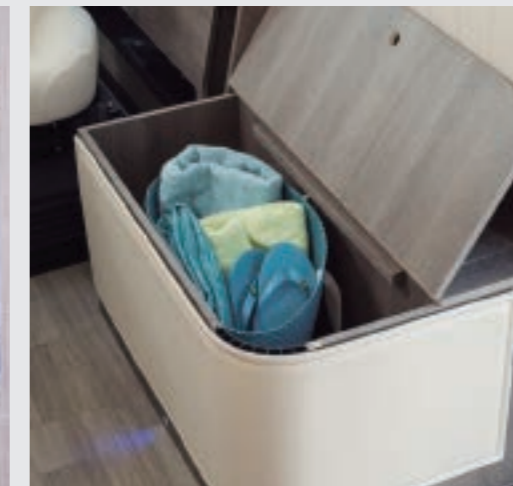

5 Great storage in side sofa.



6 Rear storage hatch.



7 AL-KO frame with double pass-through floor K. Yacht Tekno Line.



8 AL-KO frame with double pass-through floor K. Yacht Tekno Design.



# MOBILVETTA

// DOUBLE FLOOR

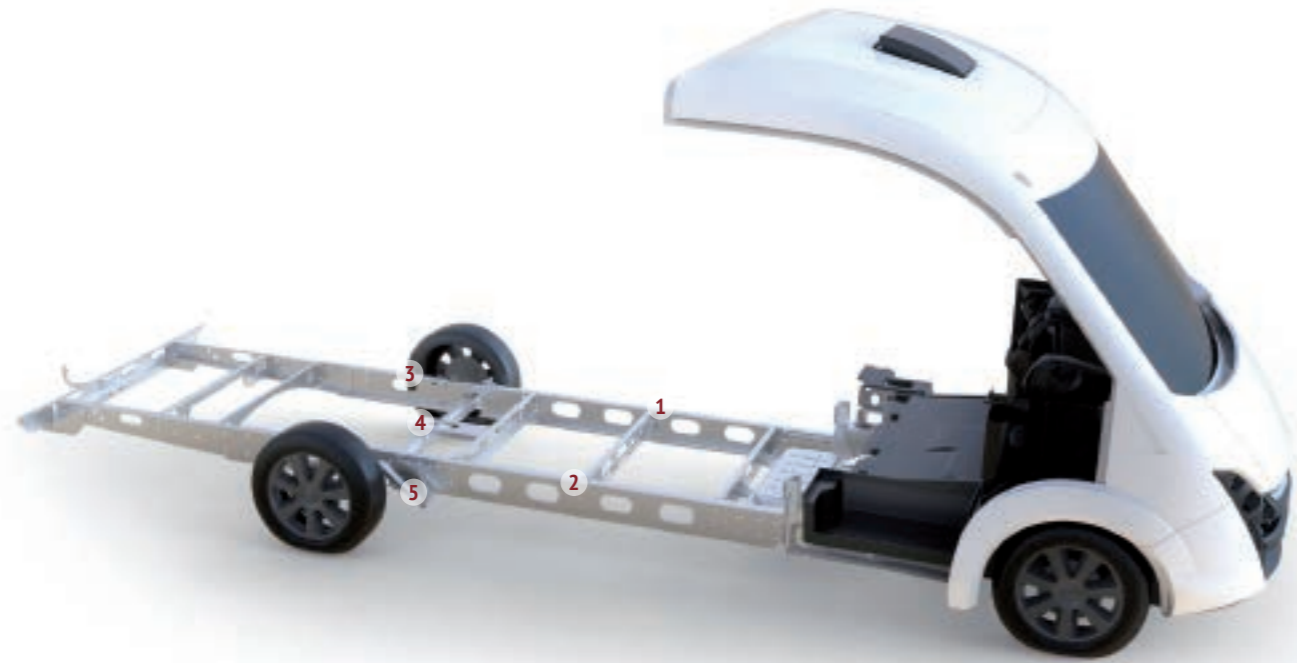

**AL-KO**

- 1 AMC lowered frame with modular construction system featuring low weight
- 2 Hot-galvanised frame
- 3 Axle with wider track
- 4 Torsion bar axle
- 5 Independent wheel suspensions

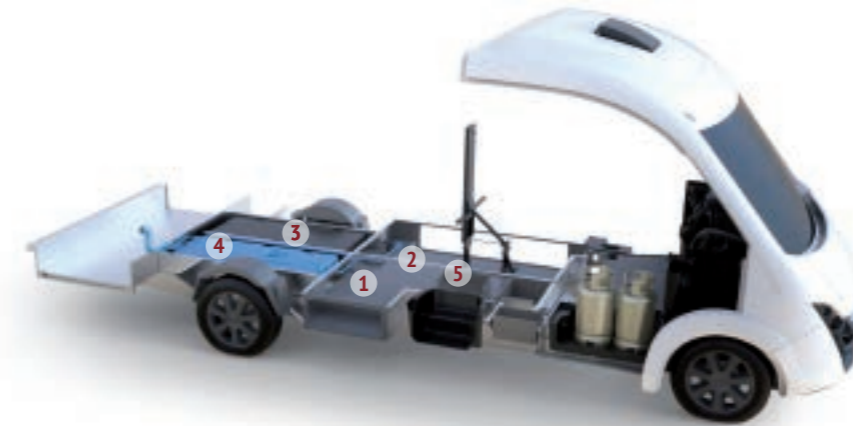

- 1 Bottom floor
- 2 Upper floor reinforcement structure
- 3 Drain water tank housing compartment
- 4 Fresh water tank housing compartment
- 5 Technical compartment for electric system

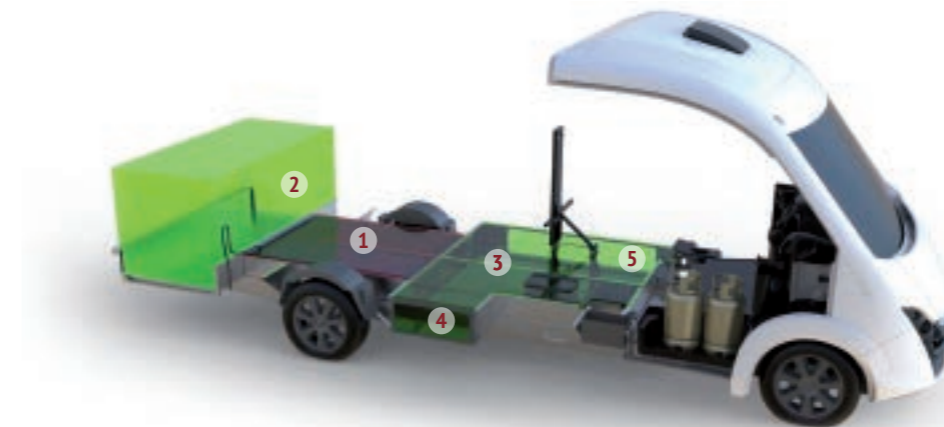

- 1 Technical volume of tank located on the rear axle (lower centreline effect)
- 2 Volume of rear locker (layout with garage)
- 3 Volume of front pass-through locker
- 4 Access to the pass-through locker (RH side)
- 5 Access to the pass-through locker (LH side)



# // SAFETY FIRST AND FOREMOST



## // Test Drive-Track in Vairano di Vidigulfo

Recreational vehicles aren't cars, and that's exactly why you need to know how to react in emergency conditions to drive them safely. And that's why Mobilvetta has organised the first safe driving course for leisure vehicles.



Handling



Anti-lock



Roadholding



Anti-skid



## // STANDARD MECHANICAL EQUIPMENT

<i>K.Silver i</i>	<i>K.Yacht</i> TECHNO TRIM	<i>K.Yacht</i> TECHNO DESIGN
Passenger Air-Bag	Passenger Air-Bag	Passenger Air-Bag
Cab manual Air conditioning	Cab manual Air conditioning	Cab manual Air conditioning
Cruise Control	Cruise Control	Cruise Control
Alloy wheels 16 "inches	Esp And Traction+ With Hill Descent	Esp And Traction+ With Hill Descent
Electric rear view mirrors with defroster	High Level Dashboard	High Level Dashboard
Radio presetting-radio and loudspeakers pre-setting	Loungetrिम Level (Dashboard with Bronze decoration)	Loungetrिम Level (Dashboard with Bronze decoration)
Cup Holder	Leather Steering wheel and gear box knob	Leather Steering wheel and gear box knob
Swivel frontseats	Alloy wheels 16 " inches	Alloy wheels 16 " inches
Radio aerial integrated in the mirror	Electric rear view mirrors with defroster	Electric rear view mirrors with defroster
LED DRL	Radio presetting-radio and loudspeakers pre-setting	Radio presetting-radio and loudspeakers pre-setting
	Cup Holder	Cup Holder
	Swivel frontseats	Swivel frontseats
	Radio aerial integrated in the mirror	Radio aerial integrated in the mirror
	LED DRL	LED DRL

## // OPTIONAL MECHANICAL EQUIPMENT

<i>K.Silver i</i>	<i>K.Yacht</i> TECHNO TRIM	<i>K.Yacht</i> TECHNO DESIGN
Automatic Air-Conditioning	Automatic Air-Conditioning	Automatic Air-Conditioning
Esp And Traction+ With Hill Descent	Steering wheel radio controls (Bluetooth Radio)	Steering wheel radio controls (Bluetooth Radio)
High Level Dashboard	Bluetooth Radio	Bluetooth Radio
Techno Trim Level (Dashboard with silver decoration)	High-level Radio (Radio steeringwheel control incl)	High-level Radio (Radio steeringwheel control incl)
Steering wheel radio controls	High-level Radio - Tom Tom Navi (Radio steeringwheel control incl)	High-level Radio - Tom Tom Navi (Radio steeringwheel control incl)
Bluetooth Radio	Automatic Gearbox	Automatic Gearbox
High-level Radio (Radio steeringwheel control incl)		
High-level Radio - Tom Tom Navi (Radio steeringwheel control incl)		
Steering wheel and gear box knob leather		
Automatic Gearbox		

## // STANDARD MECHANICAL EQUIPMENT

<i>K.ca M</i>	<i>K.ca P</i> TECHNO TRIM	<i>K.Silver</i>
Passenger Air-Bag	Passenger Air-Bag	Passenger Air-Bag
Cab manual Air conditioning	Cab manual Air conditioning	Cab manual Air conditioning
Cruise Control	Cruise Control	Cruise Control
Black Grill	Black Grill	Black Grill
Black Skidplate	Black Skidplate	Black Skidplate
Electric rear view mirrors with defroster	Electric rear view mirrors with defroster	Electric rear view mirrors with defroster
Radio presetting-radio and loudspeakers pre-setting	Radio presetting-radio and loudspeakers pre-setting	Radio presetting-radio and loudspeakers pre-setting
Frontbumper in white	Frontbumper in white	Frontbumper in white
Cup Holder	Cup Holder	Cup Holder
Swivel frontseats	Swivel frontseats	Swivel frontseats
Radio aerial integrated in the mirror	Radio aerial integrated in the mirror	Radio aerial integrated in the mirror

## // OPTIONAL MECHANICAL EQUIPMENT

<i>K.ca M</i>	<i>K.ca P</i> TECHNO TRIM	<i>K.Silver</i>
Automatic Air-Conditioning	Automatic Air-Conditioning	Automatic Air-Conditioning
Esp And Traction+ With Hill Descent	Esp And Traction+ With Hill Descent	Esp And Traction+ With Hill Descent
High Level Dashboard	High Level Dashboard	High Level Dashboard
Techno Trim Level (Dashboard with silver decoration)	Techno Trim Level (Dashboard with silver decoration)	Techno Trim Level (Dashboard with silver decoration)
Steering wheel radio controls (Bluetooth Radio)	Steering wheel radio controls (Bluetooth Radio)	Steering wheel radio controls (Bluetooth Radio)
Bluetooth Radio	Bluetooth Radio	Bluetooth Radio
High-level Radio (Radio steeringwheel control incl)	High-level Radio (Radio steeringwheel control incl)	High-level Radio (Radio steeringwheel control incl)
High-level Radio - Tom Tom Navi (Radio steeringwheel control incl)	High-level Radio - Tom Tom Navi (Radio steeringwheel control incl)	High-level Radio - Tom Tom Navi (Radio steeringwheel control incl)
Steering wheel and gear box knob leather	Steering wheel and gear box knob leather	Steering wheel and gear box knob leather
Alloy wheels 16 " inches	Alloy wheels 16 " inches	Alloy wheels 16 " inches
LED DRL	LED DRL	LED DRL
Fog lights	Fog lights	Fog lights
Automatic Gearbox	Automatic Gearbox	Automatic Gearbox
Painted door handles	Painted door handles	Painted door handles
Metallic painting	Metallic painting	Metallic painting



K-Yacht TD 79 // 7,44 MT

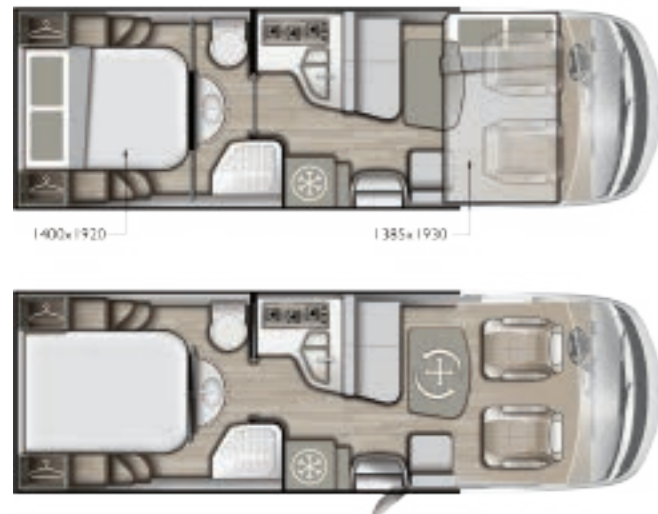

Model	MH-79	
Chassis	Weight OPT	FIAT Ducato X290 cc.2300 Multijet (Opt: AL-KO)
Number of beds	--	4
Approved seats (3500 kg)	--	4
Approved seats (3650 kg)	--	4
5th homologated seat in running order	94,0	--



K-Yacht TD 85 // 7,44 MT

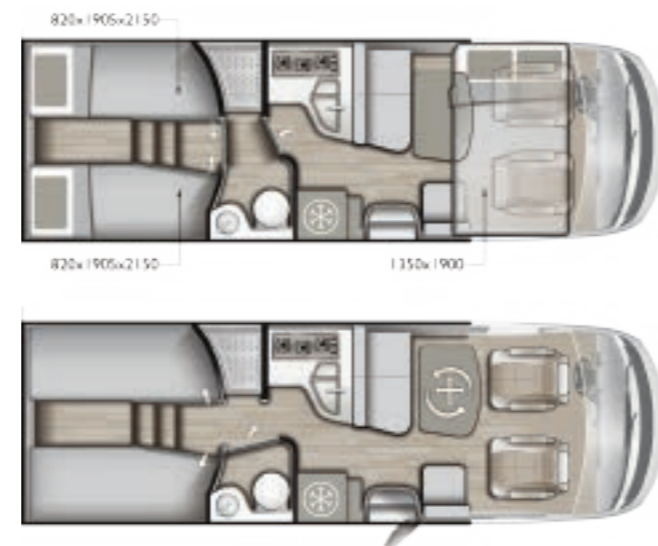

Model	MH-85	
Chassis	Weight OPT	FIAT Ducato X290 cc.2300 Multijet (Opt: AL-KO)
Number of beds	--	4
Approved seats (3500 kg)	--	4
Approved seats (3650 kg)	--	4
5th homologated seat in running order	94,0	--



K-Yacht TD 89 // 7,44 MT

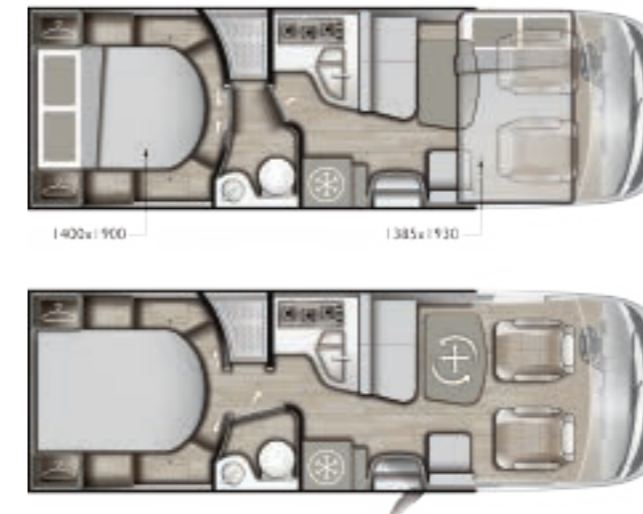

Model	MH-89	
Chassis	Weight OPT	FIAT Ducato X290 cc.2300 Multijet (Opt: AL-KO)
Number of beds	--	4
Approved seats (3500 kg)	--	4
Approved seats (3650 kg)	--	4
5th homologated seat in running order	94,0	--

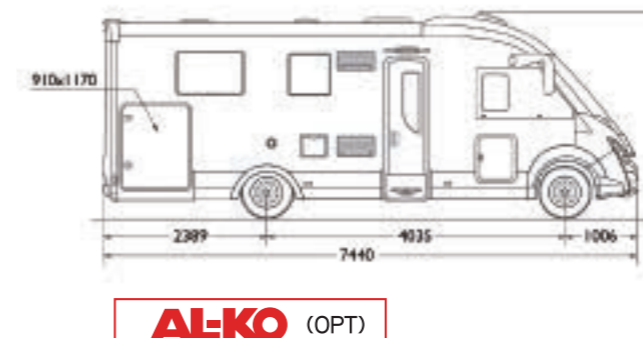



# // ALL AS STANDARD



Great aerodynamics.

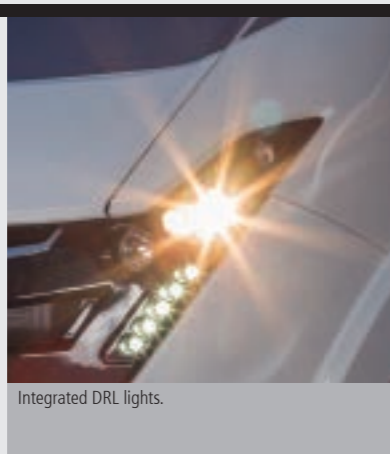

Integrated DRL lights.



Alloy wheels 16"

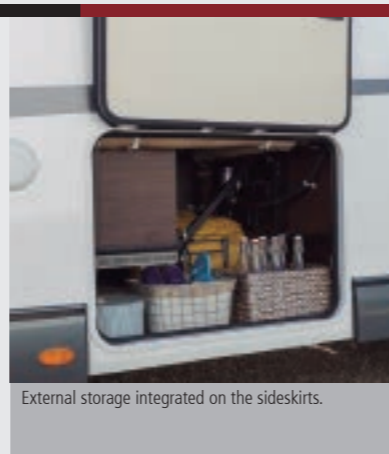

External storage integrated on the sideskirts.



CSS -CELL SOUND SYSTEM Audio diffusion system for the day area and night area.



External water intake with warm / cold mixer as practical shower and standard equipment.



Multifunction external socket for TV -12 / 220 volt and satellite.



Welcome Home-external lighting.



V-Sofa-Ergonomic two-seater sofa with V-shaped armrests.



Swivel seats with double armrests and integrated belt.



Socket with USB input for recharging your tech devices.

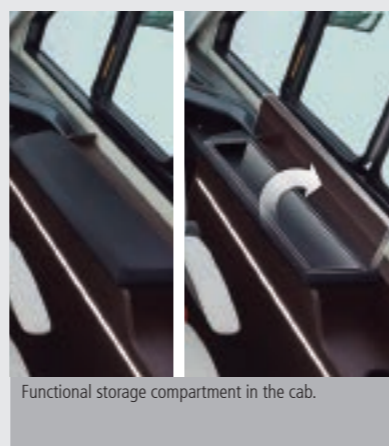

Functional storage compartment in the cab.



Functional storage compartment.



V-Light - Smart LEAN BUS technology permitting lighting adjustment through a single control panel.



Mobilvetta branded carpets.



Ornamental LED lighting.

Model	Weight OPT	K-YACHT Tekno Design MH-79			K-YACHT Tekno Design MH-85			K-YACHT Tekno Design MH-89		
		FIAT Ducato X290 cc.2300 Multijet (Opt: AL-KO)	130	150	180	130	150	180	130	150
Chassis										
Power HP	--	130	150	180	130	150	180	130	150	180
Power kW	--	96	110	130	96	110	130	96	110	130
Maximum permissible mass kg (*)	--	3500 / 3650			3500 / 3650			3500 / 3650		
Total mass in running order kg	--	3158 / 3257			3158 / 3257			3158 / 3257		
Max. user payload kg.	--	342 / 393			342 / 393			342 / 393		
max. Towing capacity kg (braked)	--	2000			2000			2000		
Maximum allowed mass kg (chassis Heavy 130cv/150-180cv)	40,0	4250 / 4400			4250 / 4400			4250 / 4400		
Heated windshield (only MOTORHOME)	1,0	Opt			Opt			Opt		
Rear parking sensors	2,0	Opt			Opt			Opt		
LOUNGETRIM LEVEL (bronze dashboard)	1,0	STD			STD			STD		
Automatic gear box	18,0	Opt			Opt			Opt		
Manual cab air conditioning	--	STD			STD			STD		
Automatic cab air conditioning	0,0	Opt			Opt			Opt		
Fresh water tank Lt. (total capacity when stopped)	--	120 Lit.			120 Lit.			120 Lit.		
Fresh water tank Lt. (total capacity when on the way) **	--	20 Lit.			20 Lit.			20 Lit.		
Waste water tank Lt.	--	125 Lit.			100 Lit.			100 Lit.		
Three-way fridge Lt.	--	150 Lit.			150 Lit.			150 Lit.		
Oven	14,0	Opt			Opt			Opt		
Heating system / Heater with air ventilation	--	COMBI 6			COMBI 6			COMBI 6		
Heating system COMBI Diesel / COMBI EH	2,0	Opt			Opt			Opt		
Heated floor	7,0	STD			STD			STD		
Front transparent rooflight (40x40 cm) / drop-down bed	--	STD			STD			STD		
Front Rooflight MIDI-HEKI, (50x70 cm)	--	STD			STD			STD		
Transparent rooflight (40x40 cm) (kitchen area)	--	STD			STD			STD		
Turbovent (40 x 40 cm) (kitchen area)	1,0	Opt			Opt			Opt		
Transparent rooflight (28x28 cm) (bathroom)	--	STD			STD			STD		
Rear Rooflight MIDI-HEKI, (50x70 cm)	--	STD			STD			STD		
Dinette table with 360 ° rotation	--	STD			STD			STD		
Rear bed electrically adjustable	--	STD			-----			STD		
Matress cover	2,0	Opt			Opt			Opt		
Entrance door with mosquito net, window and dustbin	--	STD			STD			STD		
Carpet living area	7,0	Opt			Opt			Opt		
Pres-setting for rear-camera / Rear camera	1,0	STD / Opt			STD / Opt			STD / Opt		
COLD KIT (Outisde mats for cabin + dashboard mats)	8,0	Opt			Opt			Opt		
Solar Panel 120W + REGULATOR	11,0	Opt			Opt			Opt		
External mirror with camera	1,0	Opt			Opt			Opt		
Prewiring second battery	0,5	Opt			Opt			Opt		
See	--									
*) Calculated mass on light 130 hp										
***) Pls. Check 20 lts. filling before driving	--									
***) WINTER PACK : Insulated waste water tank and exhaust valve with antifreezing resistor	--									



K-Yacht TKL 79 // 7,43 MT

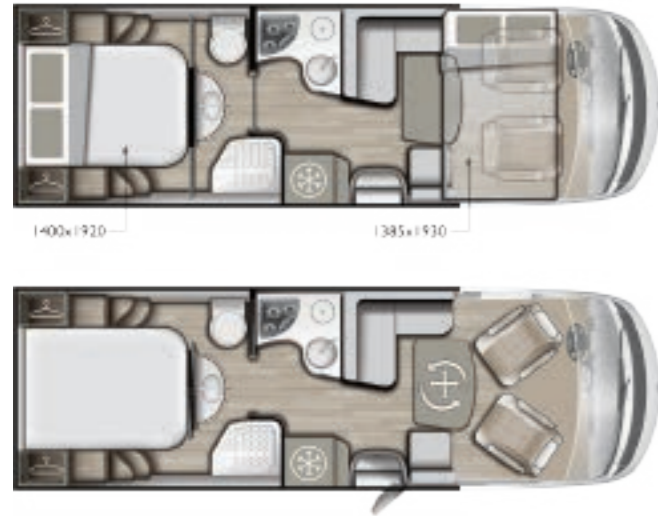

Model	MH-79	
Chassis	Weight OPT	FIAT Ducato X290 cc.2300 Multijet (Opt: AL-KO)
Number of beds	--	4
Approved seats (3500 kg)	--	4
Approved seats (3650 kg)	--	4
5th homologated seat in running order	94,0	Opt (3650 kg)



**AL-KO** (OPT)

K-Yacht TKL 80 // 6,99 MT



Model	MH-80	
Chassis	Weight OPT	FIAT Ducato X290 cc.2300 Multijet
Number of beds	--	4
Approved seats (3500 kg)	--	4
Approved seats (3650 kg)	--	4
5th homologated seat in running order	94,0	Opt (3650 kg)



K-Yacht TKL 85 // 7,38 MT

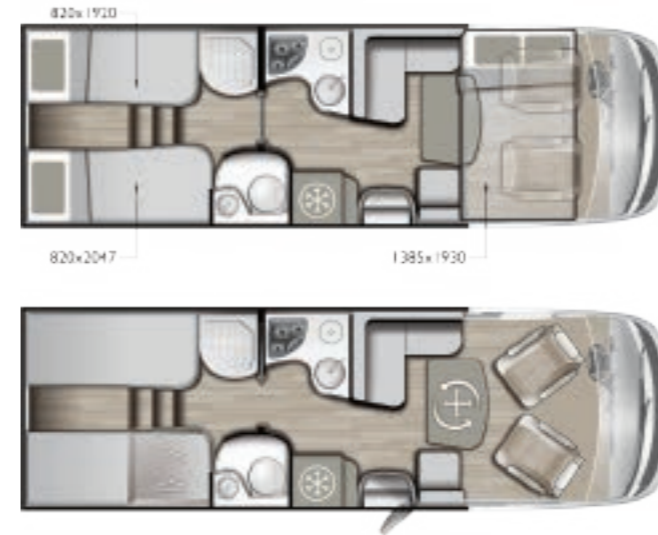

Model	MH-85	
Chassis	Weight OPT	FIAT Ducato X290 cc.2300 Multijet (Opt: AL-KO)
Number of beds	--	4
Approved seats (3500 kg)	--	4
Approved seats (3650 kg)	--	4
5th homologated seat in running order	94,0	Opt (3650 kg)

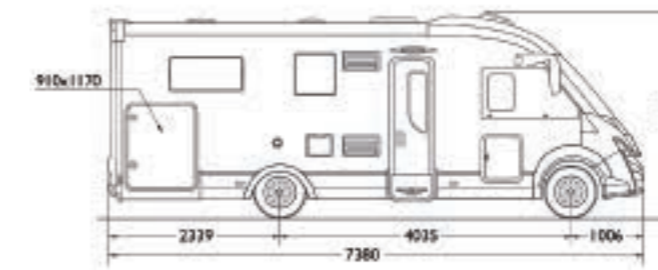

**AL-KO** (OPT)

K-Yacht TKL 89 // 7,43 MT

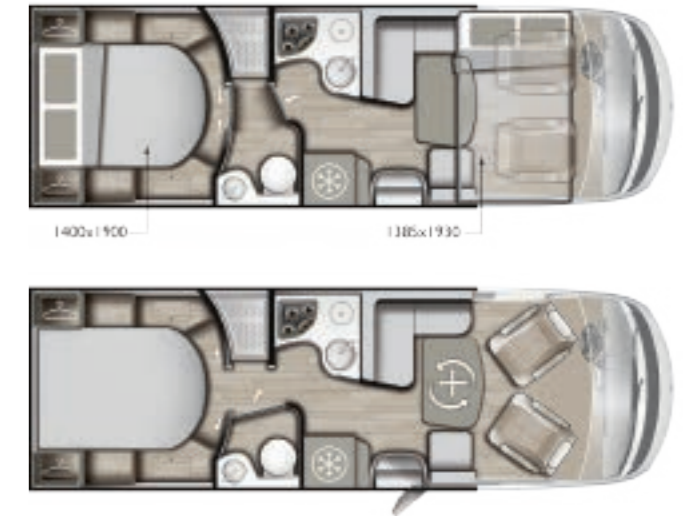

Model	MH-89	
Chassis	Weight OPT	FIAT Ducato X290 cc.2300 Multijet (Opt: AL-KO)
Number of beds	--	4
Approved seats (3500 kg)	--	4
Approved seats (3650 kg)	--	4
5th homologated seat in running order	94,0	Opt (3650 kg)



**AL-KO** (OPT)



# // ALL AS STANDARD



Great aerodynamics.



Integrated DRL lights.

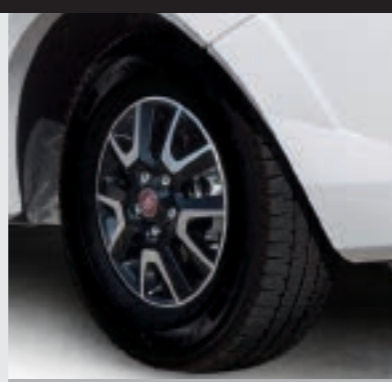

Alloy wheels 16"



External storage integrated on the sideskirts.



Centralized locking cabin / body with remote control.



External water intake with warm / cold mixer as practical shower and standard equipment.



Multifunction external socket for TV -12 / 220 volt and satellite.



Welcome Home-external lighting.



Brightness regulator.

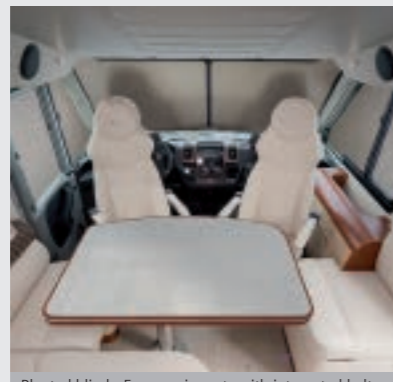

Pleated blinds. Ergonomic seats with integrated belt.



Socket with USB input for recharging your tech devices.



Multifunctional touchscreen control board.



Storage box in surface of the floor. Insulated storage compartment and container.



Tek wood panel for shower base.



Mobilvetta branded carpets.

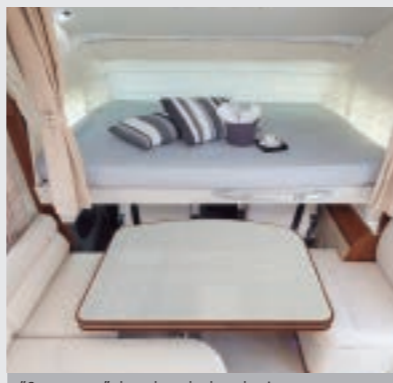

"Space-saver" drop-down bed mechanism.

Model	Weight OPT	K-YACHT Tekno Line MH-79			K-YACHT Tekno Line MH-80			K-YACHT Tekno Line MH-85			K-YACHT Tekno Line MH-89		
		FIAT Ducato X290 cc.2300 Multijet (Opt: AL-KO)	FIAT Ducato X290 cc.2300 Multijet	FIAT Ducato X290 cc.2300 Multijet (Opt: AL-KO)	FIAT Ducato X290 cc.2300 Multijet	FIAT Ducato X290 cc.2300 Multijet	FIAT Ducato X290 cc.2300 Multijet (Opt: AL-KO)	FIAT Ducato X290 cc.2300 Multijet	FIAT Ducato X290 cc.2300 Multijet (Opt: AL-KO)	FIAT Ducato X290 cc.2300 Multijet	FIAT Ducato X290 cc.2300 Multijet (Opt: AL-KO)	FIAT Ducato X290 cc.2300 Multijet	FIAT Ducato X290 cc.2300 Multijet (Opt: AL-KO)
Power HP	--	130	150	180	130	150	180	130	150	180	130	150	180
Power kW	--	96	110	130	96	110	130	96	110	130	96	110	130
Maximum permissible mass kg (*)	--	3500 / 3650			3500 / 3650			3500 / 3650			3500 / 3650		
Total mass in running order kg	--	3158 / 3257			3162 / 3163			3158 / 3257			3158 / 3257		
Max. user payload kg.	--	342 / 393			338 / 487			342 / 393			342 / 393		
max. Towing capacity kg (braked)	--	2000			2000			2000			2000		
Maximum allowed mass kg (chassis Heavy 130cv/150-180cv)	40,0	4250 / 4400			4250 / 4400			4250 / 4400			4250 / 4400		
Heated windshield (only MOTORHOME)	1,0	Opt			Opt			Opt			Opt		
Rear parking sensors	2,0	Opt			Opt			Opt			Opt		
LOUNGETRIM LEVEL (bronze dashboard)	1,0	STD			STD			STD			STD		
Steel wheels 16 "(Std. On chasis Heavy)	3,0	-----			-----			-----			-----		
Automatic gear box	18,0	Opt			Opt			Opt			Opt		
Manual cab air conditionig	--	STD			STD			STD			STD		
Automatic cab air conditioning	0,0	Opt			Opt			Opt			Opt		
Fresh water tank Lt. (total capacity when stopped)	--	120 Lit.			120 Lit.			120 Lit.			120 Lit.		
Fresh water tank Lt. (total capacity when on the way) **	--	20 Lit.			20 Lit.			20 Lit.			20 Lit.		
Waste water tank - Lt.	--	110 Lit.			110 Lit.			110 Lit.			110 Lit.		
Three-way fridge L.	--	150 Lit.			150 Lit.			150 Lit.			150 Lit.		
Oven	14,0	Opt			Opt			Opt			Opt		
Heating system / Heater with air ventilation	--	COMBI 6			COMBI 6			COMBI 6			COMBI 6		
Heating system COMBI Diesel/COMBI EH	2,0	Opt			Opt			Opt			Opt		
Heated floor	7,0	STD			STD			STD			STD		
Front transparent rooflight (40x40 cm) / drop-down bed	--	STD			STD			STD			STD		
Front Rooflight HEKI III (60x90 cm)	6,0	STD			-----			STD			STD		
Transparent rooflight (40x40 cm) (kitchen area)	--	-----			STD			-----			-----		
Transparent rooflight (28x28 cm) (bathroom)	--	STD			STD			STD			STD		
Rear Rooflight MIDI-HEKI, (50x70 cm)	--	STD			STD			STD			STD		
Rear Rooflight HEKI 3 (60x90 cm)	6,0	Opt			Opt			Opt			Opt		
Rear bed electrically adjustable	--	STD			STD			-----			STD		
Matress cover	2,0	Opt			Opt			Opt			Opt		
Entrance door with mosquito net, window and dustbin	--	STD			STD			STD			STD		
Carpet living area	7,0	Opt			Opt			Opt			Opt		
Pres-setting for rear-camera / Rear camera	1,0	STD / Opt			STD / Opt			STD / Opt			STD / Opt		
COLD KIT (Outside mats for cabin + dashboard mats)	8,0	Opt			Opt			Opt			Opt		
Solar Panel 120W + REGULATOR	11,0	Opt			Opt			Opt			Opt		
See	--												
*) Calculated mass on light 130 hp													
**) Pls. Check 20 lts. filling before driving	--												
***) WINTER PACK: Insulated waste water tank and exhaust valve with antifreezing resistor	--												
Weight OPT	--												



K-Silver i 56 // 7,40 MT

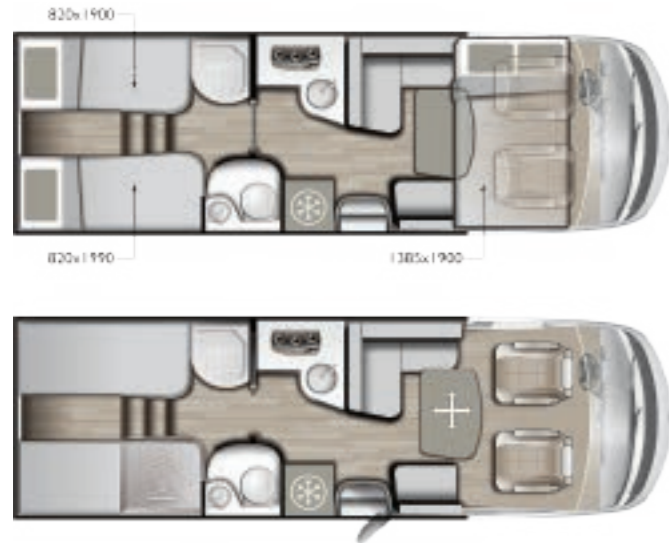

K-SILVER i		
Model	MH-56	
Chassis	Weight OPT	FIAT Ducato X290 cc.2300 Multijet
Number of beds	--	4
Approved seats (3500 kg)	--	4
Approved seats (3650 kg)	--	4
5th homologated seat in running order	94,0	Opt

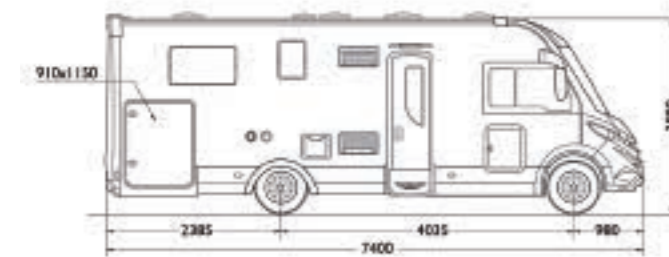

K-Silver i 58 // 7,40 MT

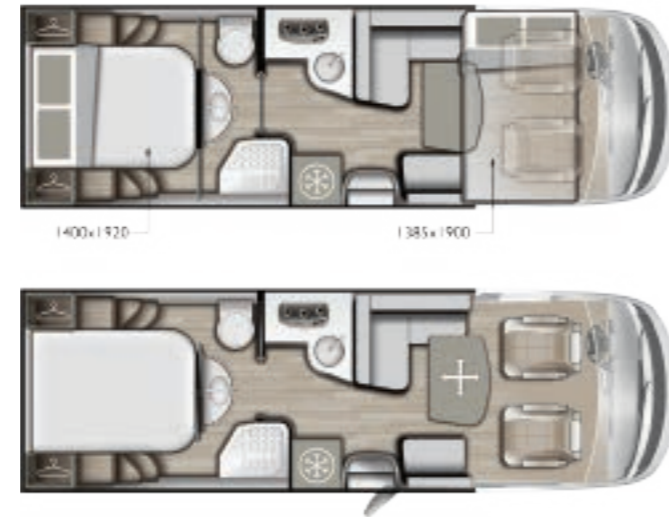

K-SILVER i		
Model	MH-58	
Chassis	Weight OPT	FIAT Ducato X290 cc.2300 Multijet
Number of beds	--	4
Approved seats (3500 kg)	--	4
Approved seats (3650 kg)	--	4
5th homologated seat in running order	94,0	Opt

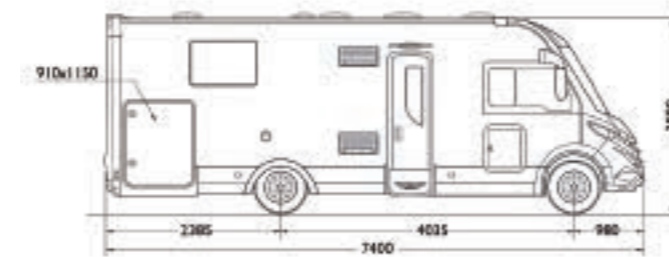

K-Silver i 59 // 7,40 MT

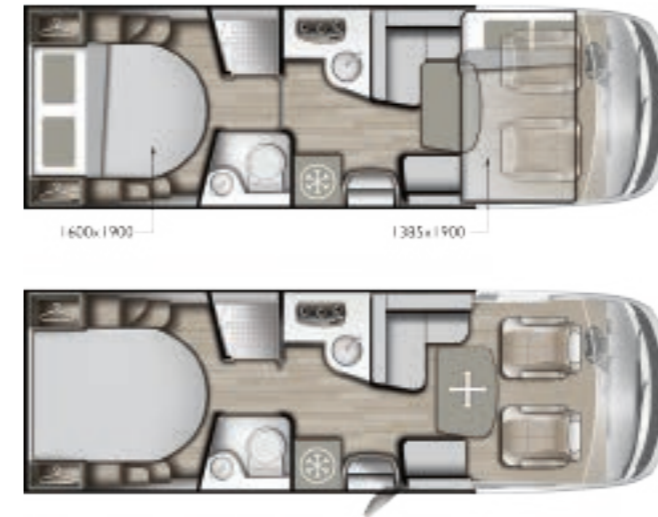

K-SILVER i		
Model	MH-59	
Chassis	Weight OPT	FIAT Ducato X290 cc.2300 Multijet
Number of beds	--	4
Approved seats (3500 kg)	--	4
Approved seats (3650 kg)	--	4
5th homologated seat in running order	94,0	Opt

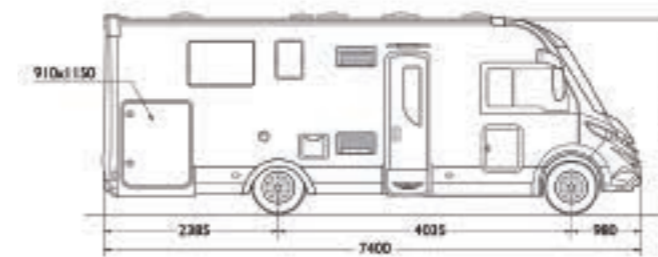



# // ALL AS STANDARD

*KSilver i*

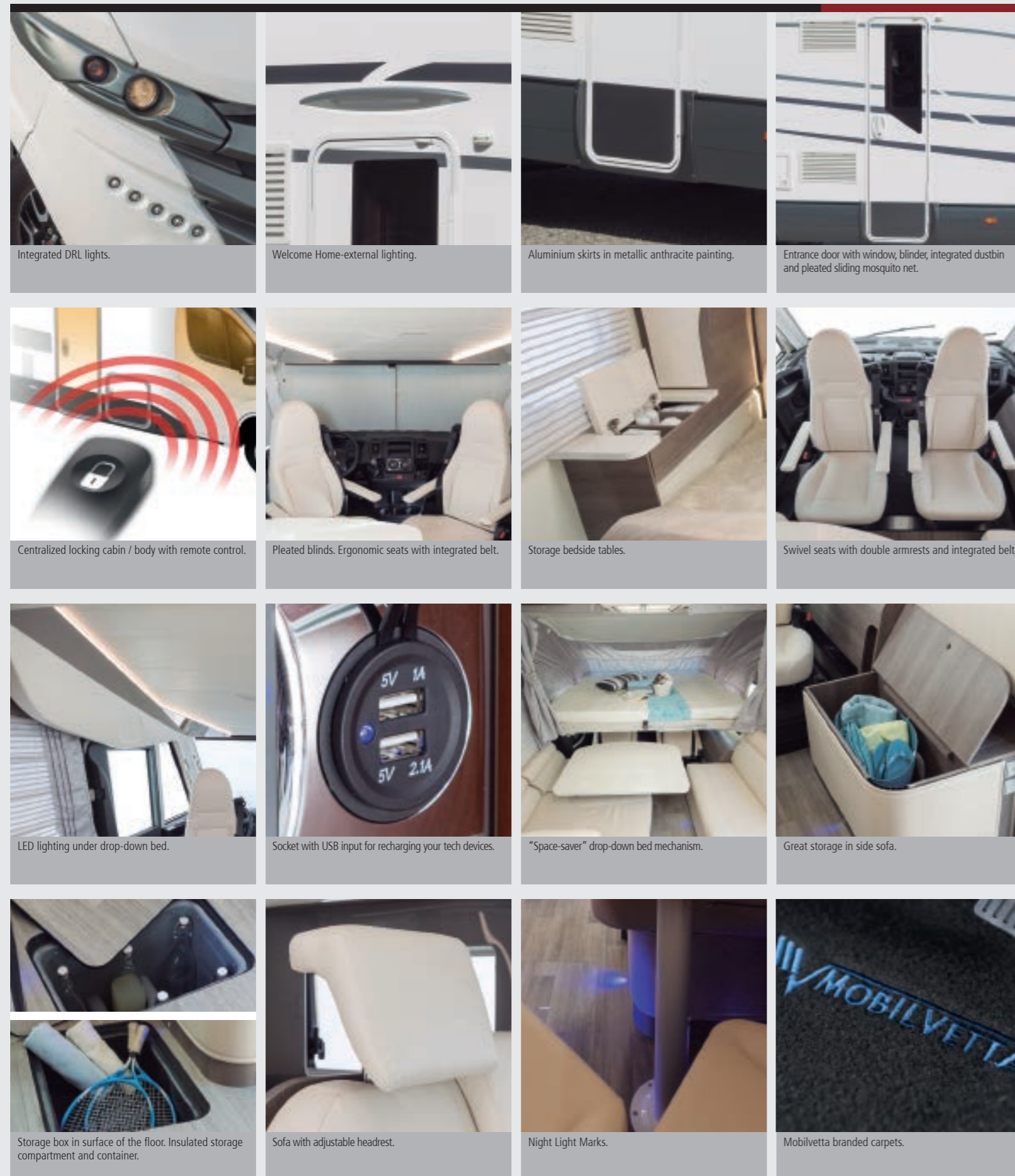

Integrated DRL lights.

Welcome Home-external lighting.

Aluminium skirts in metallic anthracite painting.

Entrance door with window, blinder, integrated dustbin and pleated sliding mosquito net.

Centralized locking cabin / body with remote control.

Pleated blinds. Ergonomic seats with integrated belt.

Storage bedside tables.

Swivel seats with double armrests and integrated belt.

LED lighting under drop-down bed.

Socket with USB input for recharging your tech devices.

"Space-saver" drop-down bed mechanism.

Great storage in side sofa.

Storage box in surface of the floor. Insulated storage compartment and container.

Sofa with adjustable headrest.

Night Light Marks.

Mobilvetta branded carpets.

	Weight OPT	K-SILVER i			K-SILVER i			K-SILVER i		
		MH-56			MH-58			MH-59		
Chassis		FIAT Ducato X290 cc.2300 Multijet			FIAT Ducato X290 cc.2300 Multijet			FIAT Ducato X290 cc.2300 Multijet		
Power HP	--	130	150	180	130	150	180	130	150	180
Power kW	--	96	110	130	96	110	130	96	110	130
Maximum permissible mass kg (*)	--	3500 / 3650			3500 / 3650			3500 / 3650		
Total mass in running order kg	--	3158 / 3163			3158 / 3163			3158 / 3163		
Max. user payload kg.	--	342 / 487			342 / 487			342 / 487		
max. Towing capacity kg (braked)	--	2000			2000			2000		
Maximum allowed mass kg (chassis Heavy 130cv/150-180cv)	40,0	4250 / 4400			4250 / 4400			4250 / 4400		
Heated windshield (only MOTORHOME)	1,0	Opt			Opt			Opt		
Rear parking sensors	2,0	Opt			Opt			Opt		
TECHNOTRIM LEVEL (silver dashboard)	1,0	Opt			Opt			Opt		
Alloy wheels 15"	--	--			--			--		
Alloy wheels (16" only)	3,0	STD			STD			STD		
Automatic gear box	18,0	Opt			Opt			Opt		
Manual cab air conditionig	--	STD			STD			STD		
Automatic cab air conditioning	0,0	Opt			Opt			Opt		
Fresh water tank Lt. (total capacity when stopped)	--	120 Lit.			120 Lit.			120 Lit.		
Fresh water tank Lt. (total capacity when on the way) **	--	20 Lit.			20 Lit.			20 Lit.		
Waste water tank Lt.	--	110 Lit.			110 Lit.			110 Lit.		
Three-way fridge Lt.	--	150 Lit.			150 Lit.			150 Lit.		
Oven	14,0	Opt			Opt			Opt		
Heating system / Heater with air ventilation	--	COMBI 4			COMBI 4			COMBI 4		
Heating system COMBI Diesel / COMBI EH	2,0	Opt			Opt			Opt		
Heated floor	7,0	Opt			Opt			Opt		
Front transparent rooflight (40x40 cm) / drop-down bed	--	STD			STD			STD		
Front Rooflight MIDI-HEKI, (50x70 cm)	--	STD			STD			STD		
Front Rooflight HEKI III (60x90 cm)	6,0	Opt			Opt			Opt		
Transparent rooflight (40x40 cm) (kitchen area)	--	STD			STD			STD		
Turbovent (40 x 40 cm) (kitchen area)	1,0	Opt			Opt			Opt		
Transparent rooflight (28x28 cm) (bathroom)	--	STD			STD			STD		
Rear Rooflight MIDI-HEKI, (50x70 cm)	--	STD			STD			STD		
Rear Rooflight HEKI 3 (60x90 cm)	6,0	Opt			Opt			Opt		
External water intake with mixer	--	-----			-----			-----		
Shower platform in Tek wood	--	-----			-----			-----		
Rear bed manually adjustable	--	-----			STD			STD		
Matress cover	2,0	Opt			Opt			Opt		
Carpet living area	7,0	Opt			Opt			Opt		
Pres-setting for rear-camera / Rear camera	1,0	STD / Opt			STD / Opt			STD / Opt		
COLD KIT (Outside mats for cabin + dashboard mats)	8,0	Opt			Opt			Opt		
Solar Panel 120W + REGULATOR	11,0	Opt			Opt			Opt		
See	--									
*) Calculated mass on light 130 hp										
***) Pls. Check 20 lts. filling before driving	--									
***) WINTER PACK: Insulated waste water tank and exhaust valve with antifreezing resistor	--									



K-SILVER 54 // 6,85 MT

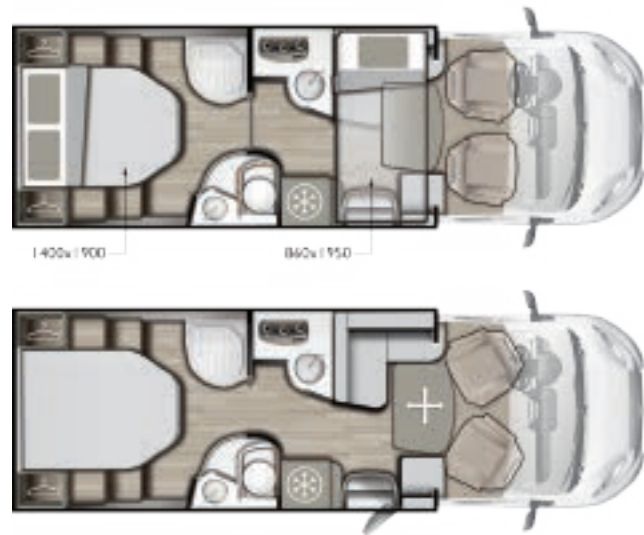

K-SILVER		
Model		54
Chassis	Weight OPT	FIAT Ducato X290 cc.2300 Multijet
Number of beds	--	4
Approved seats (3500 kg)	--	4
Approved seats (3650 kg)	--	4
5th homologated seat in running order	94,0	-----

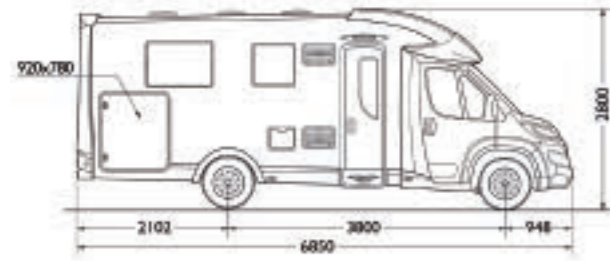

K-SILVER 56 // 7,38 MT

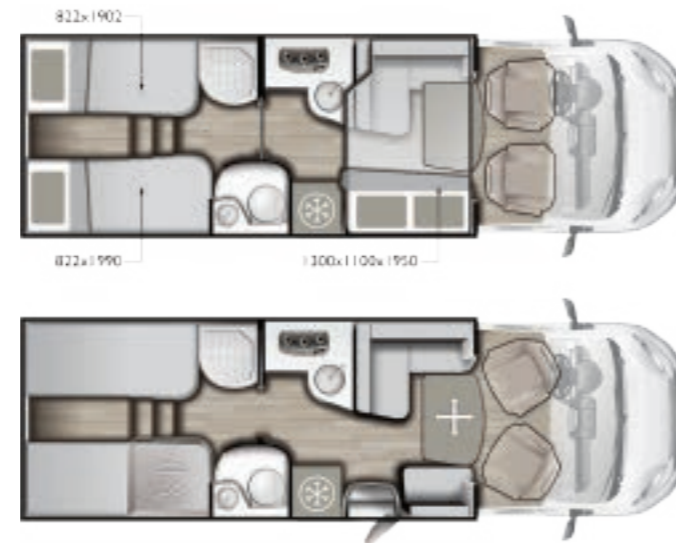

K-SILVER		
Model		56
Chassis	Weight OPT	FIAT Ducato X290 cc.2300 Multijet
Number of beds	--	5
Approved seats (3500 kg)	--	5
Approved seats (3650 kg)	--	5
5th homologated seat in running order	94,0	-----

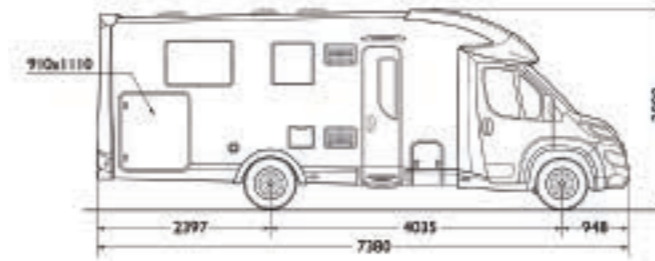

K-SILVER 58 // 7,38 MT



K-SILVER		
Model		58
Chassis	Weight OPT	FIAT Ducato X290 cc.2300 Multijet
Number of beds	--	5
Approved seats (3500 kg)	--	5
Approved seats (3650 kg)	--	5
5th homologated seat in running order	94,0	-----

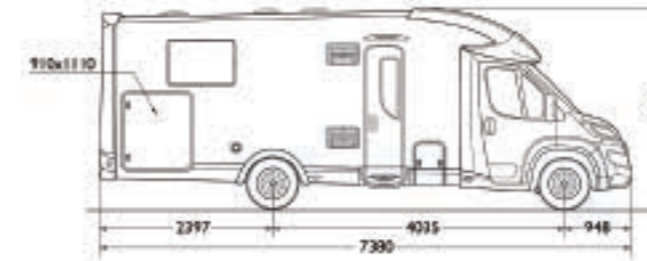

K-SILVER 59 // 7,38 MT

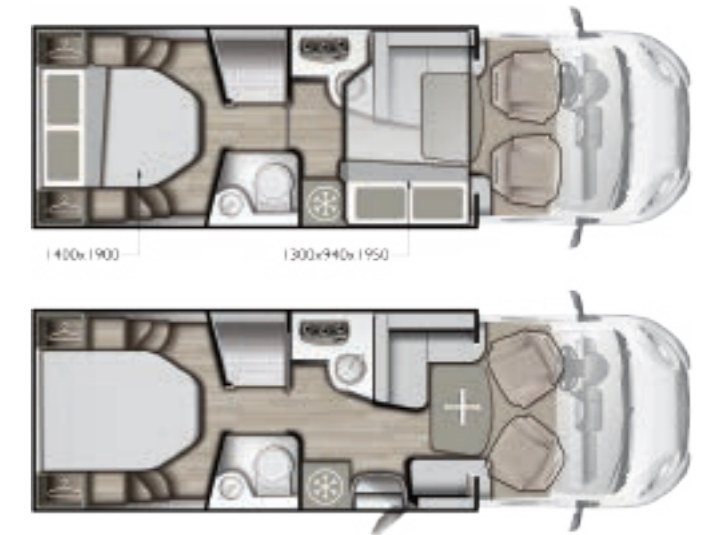

K-SILVER		
Model		59
Chassis	Weight OPT	FIAT Ducato X290 cc.2300 Multijet
Number of beds	--	5
Approved seats (3500 kg)	--	5
Approved seats (3650 kg)	--	5
5th homologated seat in running order	94,0	-----





# // ALL AS STANDARD



Front bumpers in white, black gloss front grille & black bezel headlamps, black skid plate.



Nautical style for the modern canopy with built in Sky-Dome.



Front bumpers in white.



Entrance door with window, blinder, integrated dustbin and pleated sliding mosquito net.



Centralized locking cabin / body with remote control.



Welcome Home-external lighting.



Aluminium skirts in metallic anthracite painting.



Large drawers.



Sliding basket in the kitchen peninsula.



Socket with USB input for recharging your tech devices.



Swivel seats with double armrests and integrated belt.

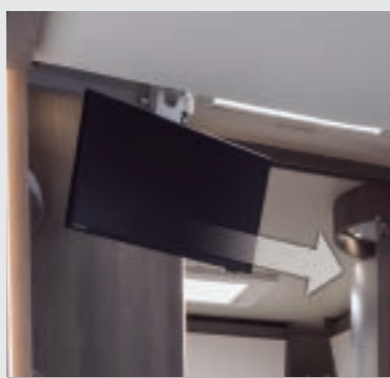

Rotating TV holder.



CP PLUS Central heating system control board Boost function for both a fast water and environment heating. Timer Heat regulator.



Support for surface.



Night Light Marks.



Winter pack.

Model	Weight OPT	K-SILVER 54			K-SILVER 56			K-SILVER 58			K-SILVER 59		
		FIAT Ducato X290 cc.2300 Multijet	FIAT Ducato X290 cc.2300 Multijet	FIAT Ducato X290 cc.2300 Multijet	FIAT Ducato X290 cc.2300 Multijet	FIAT Ducato X290 cc.2300 Multijet	FIAT Ducato X290 cc.2300 Multijet	FIAT Ducato X290 cc.2300 Multijet	FIAT Ducato X290 cc.2300 Multijet	FIAT Ducato X290 cc.2300 Multijet	FIAT Ducato X290 cc.2300 Multijet		
Power HP	--	130	150	180	130	150	180	130	150	180	130	150	180
Power kW	--	96	110	130	96	110	130	96	110	130	96	110	130
Maximum permissible mass kg (*)	--	3500 / 3650			3500 / 3650			3500 / 3650			3500 / 3650		
Total mass in running order kg	--	3157 / 3157			3073 / 3177			3073 / 3177			3073 / 3177		
Max. user payload kg.	--	422 / 493			427 / 473			427 / 473			427 / 473		
max. Towing capacity kg (braked)	--	2000			2000			2000			2000		
\$\$ Maximum allowed mass kg (chassis Heavy 130cv/150-180cv)	40,0	\$ - -			4250 / 4400			\$ - -			4250 / 4400		
Rear parking sensors	2,0	Opt			Opt			Opt			Opt		
TECHNOTRIM LEVEL (silver dashboard)	1,0	Opt			Opt			Opt			Opt		
Alloy wheels 15"	--	Opt			Opt			Opt			Opt		
\$\$\$ Alloy wheels (16" only)	3,0	\$ - -			Opt			\$ - -			Opt		
\$\$ Steel wheels 16" (Std. On chasis Heavy)	3,0	\$ - -			Opt			\$ - -			Opt		
Automatic gear box	18,0	Opt			Opt			Opt			Opt		
Manual cab air conditioning	--	STD			STD			STD			STD		
Automatic cab air conditioning	0,0	Opt			Opt			Opt			Opt		
LED DRL	0,5	Opt			Opt			Opt			Opt		
Fresh water tank Lt. (total capacity when stopped)	--	120 Lit.			120 Lit.			120 Lit.			120 Lit.		
Fresh water tank Lt. (total capacity when on the way) **	--	20 Lit.			20 Lit.			20 Lit.			20 Lit.		
Waste water tank - Lt.	--	110 Lit.			110 Lit.			110 Lit.			110 Lit.		
Three-way fridge L.	--	142 Lit.			150 Lit.			150 Lit.			150 Lit.		
Oven	14,0	Opt			Opt			Opt			Opt		
Heating system / Heater with air ventilation	--	COMBI 4			COMBI 4			COMBI 4			COMBI 4		
Heating system COMBI Diesel/COMBI EH	2,0	Opt			Opt			Opt			Opt		
Heated floor	7,0	Opt			Opt			Opt			Opt		
Front transparent rooflight (40x40 cm) / drop-down bed	--	STD			STD			STD			STD		
Transparent rooflight (40x40 cm) (kitchen area)	--	STD			STD			STD			STD		
Turbovent (40 x 40 cm) (kitchen area)	1,0	Opt			Opt			Opt			Opt		
Transparent rooflight (28x28 cm) (bathroom)	--	STD			STD			STD			STD		
Rear Rooflight MIDI-HEKI, (50x70 cm)	--	STD			STD			STD			STD		
Rear bed manually adjustable	--	STD			-----			STD			STD		
Matress cover	2,0	Opt			Opt			Opt			Opt		
Cab pleated mats	8,0	Opt			Opt			Opt			Opt		
Carpet living area	7,0	Opt			Opt			Opt			Opt		
Pres-setting for rear-camera / Rear camera	1,0	STD / Opt			STD / Opt			STD / Opt			STD / Opt		
COLD KIT (Outside mats for cabin + dashboard mats)	8,0	Opt			Opt			Opt			Opt		
Solar Panel 120W + REGULATOR	11,0	Opt			Opt			Opt			Opt		
See	--												

\*) Calculated mass on light 130 hp

\*\*) Pls. Check 20 lts. filling before driving

\*\*\*) WINTER PACK : Insulated waste water tank and exhaust valve with antifreezing resistor



KEA P65 // 7,38 MT

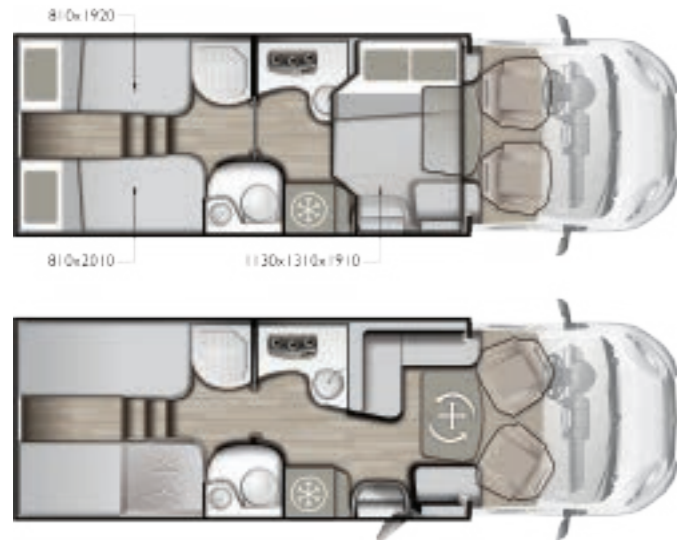

Model	P65	
Chassis	Weight OPT	FIAT Ducato X290 cc.2300 Multijet
Number of beds	--	4
Approved seats (3500 kg)	--	4
Approved seats (3650 kg)	--	4
5th homologated seat in running order	94,0	Opt (3650 kg)

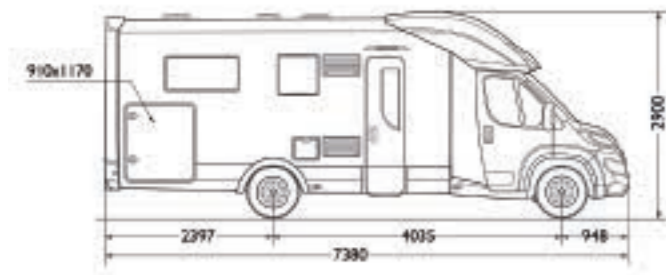

KEA P67 // 6,99 MT

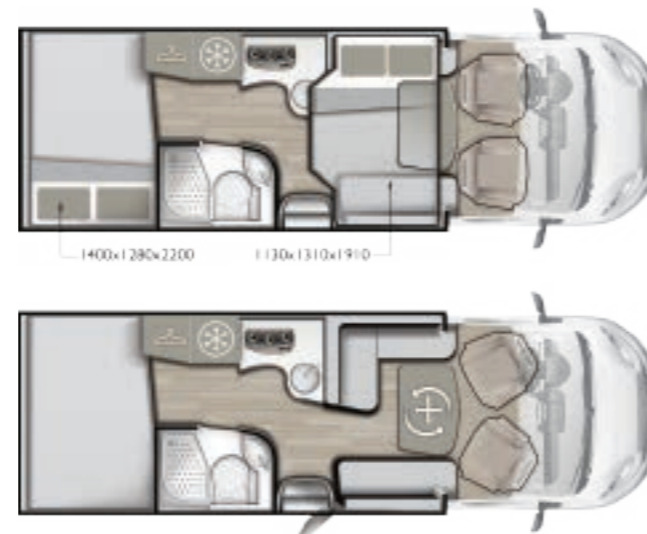

Model	P67	
Chassis	Weight OPT	FIAT Ducato X290 cc.2300 Multijet
Number of beds	--	4
Approved seats (3500 kg)	--	4
Approved seats (3650 kg)	--	4
5th homologated seat in running order	94,0	Opt



KEA P68 // 7,38 MT

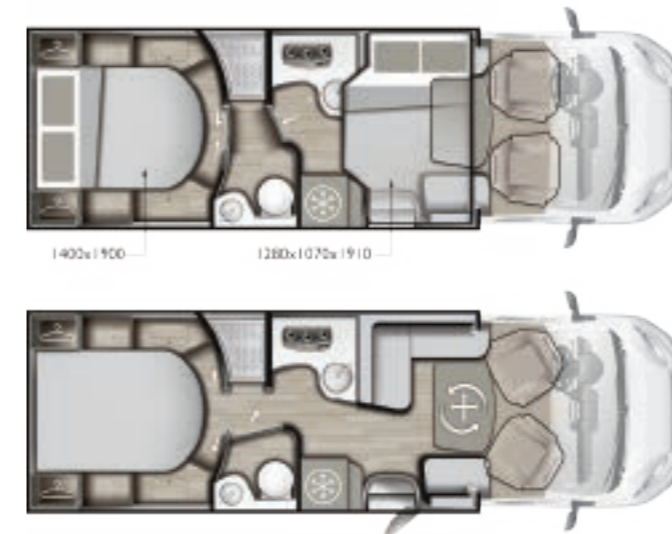

Model	P68	
Chassis	Weight OPT	FIAT Ducato X290 cc.2300 Multijet
Number of beds	--	4
Approved seats (3500 kg)	--	4
Approved seats (3650 kg)	--	4
5th homologated seat in running order	94,0	Opt (3650 kg)

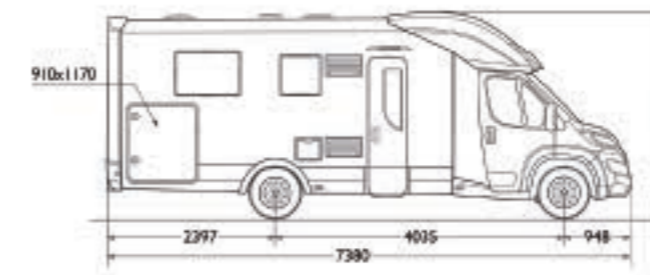



# // ALL AS STANDARD



Front bumpers in white, black gloss front grille & black bezel headlamps, black skid plate.



Nautical style for the modern canopy with built in Sky-Dome.

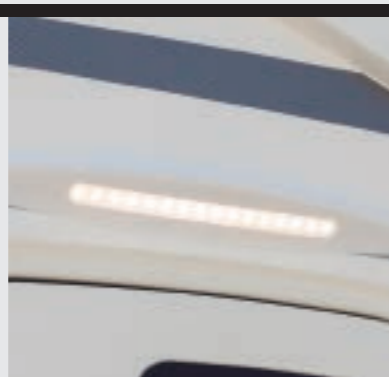

Welcome Home-external lighting.



Entrance door with window, blinder, integrated dustbin and pleated sliding mosquito net.



Centralized locking cabin / body with remote control.



External water intake with warm / cold mixer as practical shower and standard equipment.



Multifunction external socket for TV -12 / 220 volt and satellite.



External storage integrated on the side skirts.



Brightness regulator.



Socket with USB input for recharging your tech devices.



Swivel seats with double armrests and integrated belt.



Teak wood panel for shower base.



Storage box in surface of the floor. Insulated storage compartment and container.



Extractor hood.



Night Light Marks.



Mobilvetta branded carpets.

Model	Weight OPT	KEA P65			KEA P67			KEA P68		
		FIAT Ducato X290 cc.2300 Multijet	FIAT Ducato X290 cc.2300 Multijet	FIAT Ducato X290 cc.2300 Multijet	FIAT Ducato X290 cc.2300 Multijet	FIAT Ducato X290 cc.2300 Multijet	FIAT Ducato X290 cc.2300 Multijet			
Power HP	--	130	150	180	130	150	180	130	150	180
Power kW	--	96	110	130	96	110	130	96	110	130
Maximum permissible mass kg (*)	--	3500 / 3650			3500 / 3650			3500 / 3650		
Total mass in running order kg	--	3158 / 3163			3162 / 3177			3158 / 3163		
Max. user payload kg.	--	342 / 487			338 / 473			342 / 487		
max. Towing capacity kg (braked)	--	2000			2000			2000		
Maximum allowed mass kg (chassis Heavy 130cv/150-180cv)	40,0	4250 / 4400			4250 / 4400			4250 / 4400		
Heated windshield (only MOTORHOME)	1,0	-----			-----			-----		
Rear parking sensors	2,0	Opt			Opt			Opt		
TECHNOTRIM LEVEL (silver dashboard)	1,0	Opt			Opt			Opt		
Alloy wheels 15"	--	Opt			Opt			Opt		
Alloy wheels (16" only)	3,0	Opt			Opt			Opt		
Steel wheels 16"(Std. On chasis Heavy)	3,0	Opt			Opt			Opt		
Automatic gear box	18,0	Opt			Opt			Opt		
Manual cab air conditioning	--	STD			STD			STD		
Automatic cab air conditioning	0,0	Opt			Opt			Opt		
LED DRL	0,5	Opt			Opt			Opt		
Fresh water tank Lt. (total capacity when stopped)	--	120 Lit.			120 Lit.			120 Lit.		
Fresh water tank Lt. (total capacity when on the way) **	--	20 Lit.			20 Lit.			20 Lit.		
Waste water tank - Lt.	--	110 Lit.			110 Lit.			110 Lit.		
Three-way fridge L.	--	150 Lit.			150 Lit.			150 Lit.		
Oven	14,0	Opt			Opt			Opt		
Heating system / Heater with air ventilation	--	COMBI 6			COMBI 6			COMBI 6		
Heating system COMBI Diesel/COMBI EH	2,0	Opt			Opt			Opt		
Heated floor	7,0	Opt			Opt			Opt		
Front transparent rooflight (40x40 cm) / drop-down bed	--	STD			STD			STD		
Transparent rooflight (40x40 cm) (kitchen area)	--	STD			STD			STD		
Turbovent (40 x 40 cm) (kitchen area)	1,0	Opt			Opt			Opt		
Transparent rooflight (28x28 cm) (bathroom)	--	STD			STD			STD		
Rear Rooflight MIDI-HEKI, (50x70 cm)	--	STD			STD			STD		
Rear Rooflight HEKI 3 (60x90 cm)	6,0	Opt			-----			Opt		
Rear bed electrically adjustable	--	STD			STD			STD		
Matress cover	2,0	Opt			Opt			Opt		
Cab pleated mats	8,0	Opt			Opt			Opt		
Carpet living area	7,0	Opt			Opt			Opt		
Pres-setting for rear-camera / Rear camera	1,0	STD / Opt			STD / Opt			STD / Opt		
COLD KIT (Outside mats for cabin + dashboard mats)	8,0	Opt			Opt			Opt		
Solar Panel 120W + REGULATOR	11,0	Opt			Opt			Opt		
See	--									
*) Calculated mass on light 130 hp										
***) Pls. Check 20 lts. filling before driving	--									
***) WINTER PACK : Insulated waste water tank and exhaust valve with antifreezing resistor	--									



KEA M74 // 7,26 MT



Model	M74	
Chassis	Weight OPT	FIAT Ducato X290 cc.2300 Multijet
Number of beds	--	4
Approved seats (3500 kg)	--	4
Approved seats (3650 kg)	--	4
5th homologated seat in running order	94,0	Opt (3650 kg)



KEA M76 // 7,32 MT

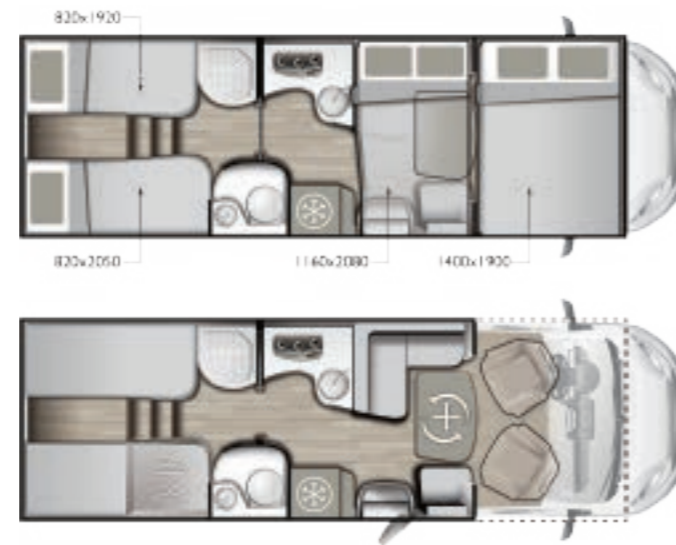

Model	M76	
Chassis	Weight OPT	FIAT Ducato X290 cc.2300 Multijet
Number of beds	--	4
Approved seats (3500 kg)	--	4
Approved seats (3650 kg)	--	4
5th homologated seat in running order	94,0	Opt (3650 kg)

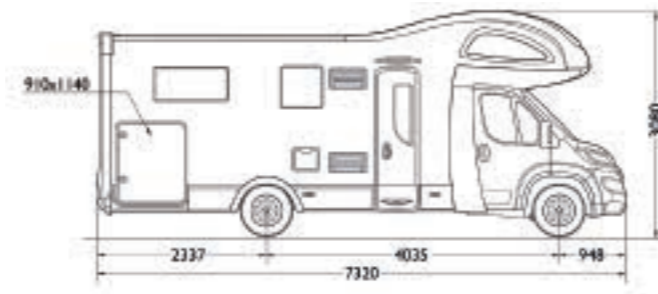

KEA M79 // 7,38 MT

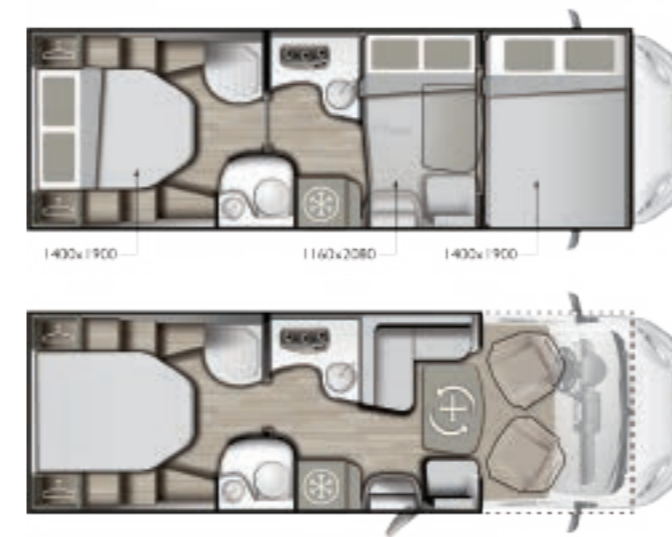

Model	M79	
Chassis	Weight OPT	FIAT Ducato X290 cc.2300 Multijet
Number of beds	--	4
Approved seats (3500 kg)	--	4
Approved seats (3650 kg)	--	4
5th homologated seat in running order	94,0	Opt (3650 kg)

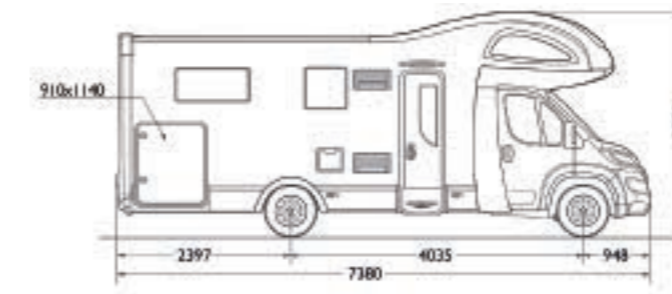



# // ALL AS STANDARD

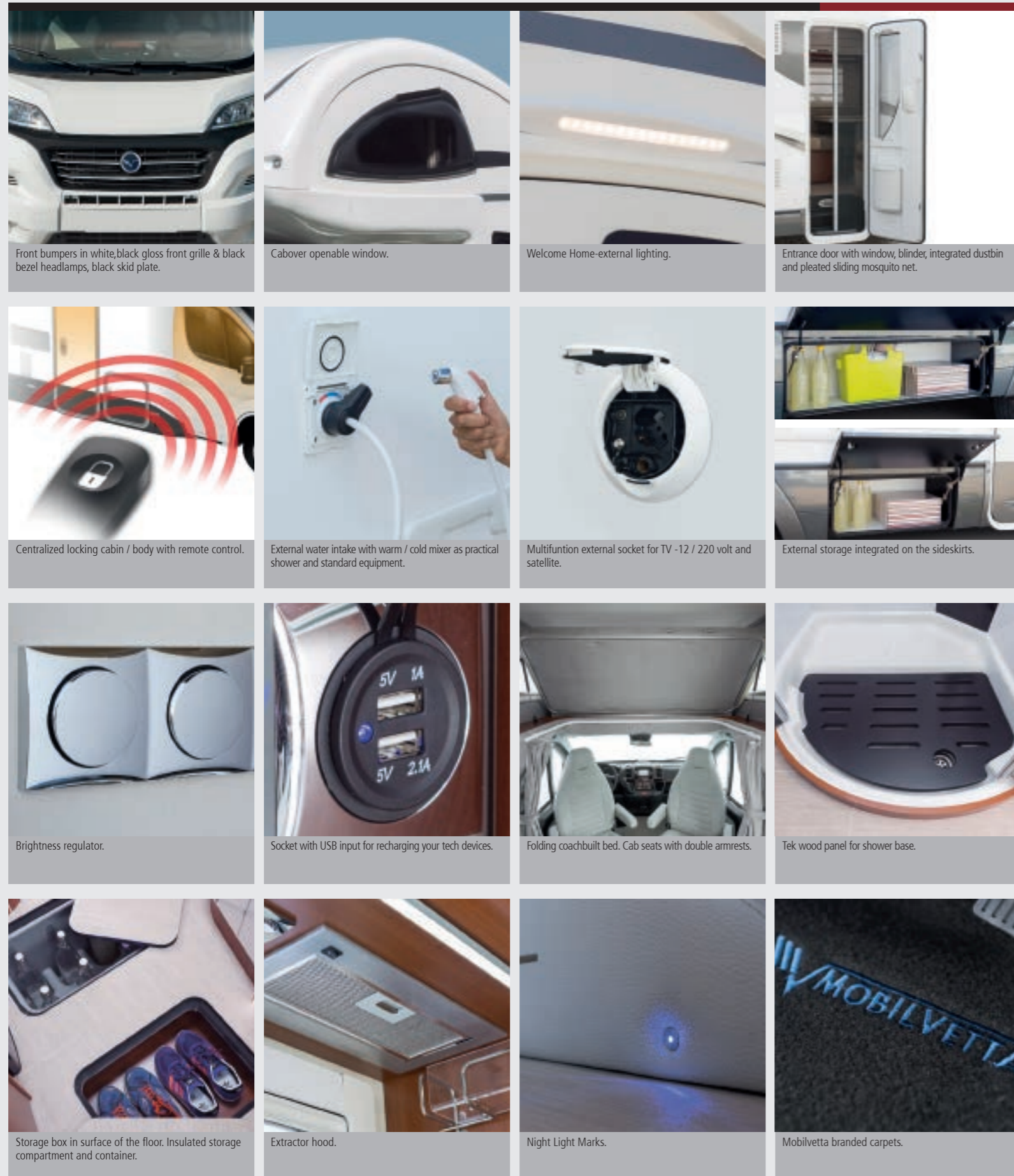

Front bumpers in white, black gloss front grille & black bezel headlamps, black skid plate.

Cabover openable window.

Welcome Home-external lighting.

Entrance door with window, blinder, integrated dustbin and pleated sliding mosquito net.

Centralized locking cabin / body with remote control.

External water intake with warm / cold mixer as practical shower and standard equipment.

Multifunction external socket for TV -12 / 220 volt and satellite.

External storage integrated on the sideskirts.

Brightness regulator.

Socket with USB input for recharging your tech devices.

Folding coachbuilt bed. Cab seats with double armrests.

Tek wood panel for shower base.

Storage box in surface of the floor. Insulated storage compartment and container.

Extractor hood.

Night Light Marks.

Mobilvetta branded carpets.

Model	KEA M74			KEA M76			KEA M79				
	Weight OPT	FIAT Ducato X290 cc.2300 Multijet		FIAT Ducato X290 cc.2300 Multijet		FIAT Ducato X290 cc.2300 Multijet					
Power HP	--	130	150	180	130	150	180	130	150	180	
Power kW	--	96	110	130	96	110	130	96	110	130	
Maximum permissible mass kg (*)	--	3500 / 3650		3500 / 3650		3500 / 3650		3500 / 3650		3500 / 3650	
Total mass in running order kg	--	3158 / 3183		3158 / 3183		3158 / 3183		3158 / 3183		3158 / 3183	
Max. user payload kg.	--	342 / 467		342 / 467		342 / 467		342 / 467		342 / 467	
max. Towing capacity kg (braked)	--	2000		2000		2000		2000		2000	
Maximum allowed mass kg (chassis Heavy 130cv/150-180cv)	40,0	4250 / 4400		4250 / 4400		4250 / 4400		4250 / 4400		4250 / 4400	
Rear parking sensors	2,0	Opt		Opt		Opt		Opt		Opt	
TECHNOTRIM LEVEL (silver dashboard)	1,0	Opt		Opt		Opt		Opt		Opt	
Alloy wheels 15"	--	Opt		Opt		Opt		Opt		Opt	
Alloy wheels (16" only)	3,0	Opt		Opt		Opt		Opt		Opt	
Steel wheels 16"(Std. On chasis Heavy)	3,0	Opt		Opt		Opt		Opt		Opt	
Automatic gear box	18,0	Opt		Opt		Opt		Opt		Opt	
Manual cab air conditionig	--	STD		STD		STD		STD		STD	
Automatic cab air conditioning	0,0	Opt		Opt		Opt		Opt		Opt	
LED DRL	0,5	Opt		Opt		Opt		Opt		Opt	
Fresh water tank Lt. (total capacity when stopped)	--	120 Lit.		120 Lit.		120 Lit.		120 Lit.		120 Lit.	
Fresh water tank Lt. (total capacity when on the way) **	--	20 Lit.		20 Lit.		20 Lit.		20 Lit.		20 Lit.	
Waste water tank - Lt.	--	110 Lit.		110 Lit.		110 Lit.		110 Lit.		110 Lit.	
Three-way fridge L.	--	150 Lit.		150 Lit.		150 Lit.		150 Lit.		150 Lit.	
Oven	14,0	Opt		Opt		Opt		Opt		Opt	
Heating system / Heater with air ventilation	--	COMBI 6		COMBI 6		COMBI 6		COMBI 6		COMBI 6	
Heating system COMBI Diesel/COMBI EH	2,0	Opt		Opt		Opt		Opt		Opt	
Heated floor	7,0	Opt		Opt		Opt		Opt		Opt	
Front Rooflight HEKI 2 (60x90 cm)	6,0	STD		STD		STD		STD		STD	
Transparent rooflight (40x40 cm) (kitchen area)	--	STD		-----		-----		-----		-----	
Transparent rooflight (28x28 cm) (bathroom)	--	STD		STD		STD		STD		STD	
Rear Rooflight MIDI-HEKI, (50x70 cm)	--	STD		STD		STD		STD		STD	
Dinette table with 360 ° rotation	--	STD		STD		STD		STD		STD	
Matress cover	2,0	Opt		Opt		Opt		Opt		Opt	
Cab pleated mats	8,0	Opt		Opt		Opt		Opt		Opt	
Carpet living area	7,0	Opt		Opt		Opt		Opt		Opt	
Pres-setting for rear-camera / Rear camera	1,0	STD / Opt		STD / Opt		STD / Opt		STD / Opt		STD / Opt	
COLD KIT (Outisde mats for cabin + dashboard mats)	8,0	Opt		Opt		Opt		Opt		Opt	
Solar Panel 120W + REGULATOR	11,0	Opt		Opt		Opt		Opt		Opt	
See	--										
*) Calculated mass on light 130 hp											
***) Pls. Check 20 lts. filling before driving	--										
***) WINTER PACK : Insulated waste water tank and exhaust valve with antifreezing resistor	--										



The masses indicated in this catalogue refer to the provisions of European Directive 2007/46/EC.

#### MASS IN RUNNING ORDER

It includes the weight of the empty BASE vehicle, of the driver (75 kg), 100% of the fuel (60-l tank), fresh water (tank filled with 20 l while travelling), and a gas tank for living purposes (20 kg).

The mass in running order, and consequently the payload and/or certified seats may vary depending on the accessories installed.

#### PAYLOAD

This consists of the difference between the maximum technically permissible laden mass and the mass in running order. It includes elements for living purposes, the transported passengers defined by the manufacturer (driver excluded), and the personal effects.

The payload calculation is based on the following parameters: 75 kg for each passenger (driver excluded), 10 kg of baggage for each passenger and for the driver, 10 kg for each metre of length of the vehicle, plus the remaining payload, which can be used for the installation of accessories or for additional baggage.

All masses and loads of the empty vehicle have a tolerance of +/- 5%, in compliance with Directive 2007/46/EC.

Any optional equipment increases the mass in running order and decreases the payload.

The weight of non-standard accessories is not included in the mass in running order indicated in this catalogue.

Additional accessories and devices reduce the payload by a quantity equal to their weight; the incidence of the weight of the individual accessories is shown in the special column in the technical data sheets or can be requested at our dealers.

In case certain accessories are installed (for example, additional elements such as coupling device or motorbike rack), the mass of these accessories will affect the payload, possibly reducing it along with the number of certified seats.

Please make sure that the maximum loads on the axles and the maximum technically permissible load mass are not exceeded during the complete loading phase of the vehicle.

The regulations and requirements of each country may entail changes in the characteristics of this table.

The number of certified seats may vary depending on the traffic regulations in force in each country.

#### NOTES:

SEA S.P.A. – MOBILVETTA reserves itself the right to change the characteristics and the furnishings of all its models with no advance notice required; all data contained in this leaflet must therefore be considered approximate and non-binding. Despite thorough checks of the contents, we cannot exclude possible printing and/or translating errors.

This catalogue does not constitute contractual documentation.

Any reproduction, including in part, of the text or of the content of this document is prohibited.

The indicated weights are exclusively approximated. Tolerances of +/- 5 % are allowed.

Generally speaking, special equipment and options increase the no-load weight and entail a reduction in the payload.

We hereby decline any and all responsibility in case structural changes are made to the vehicle; any assembly, disassembly or changes carried out by unauthorised workshops may jeopardise your safety and cause the warranty clauses to be forfeited.

For additional information on installation and technical details, please contact one of our dealers.



// VEHICLES' ORNAMENTS  
**DELIVERED BY**

LENE BJERRE // [www.lenebjerre.com](http://www.lenebjerre.com)

BORGO DE MEDICI // [www.borgodemedici.it](http://www.borgodemedici.it)

WALLY // [www.wallycosmetici.com](http://www.wallycosmetici.com)

CORALBA // [www.coralbacasa.it](http://www.coralbacasa.it)



## SEA S.p.A. MOBILVETTA

Via Val d' Aosta, 4 - I - 53036 Poggibonsi (SI)

Tel : +39 0577 99511

Fax : +39 0577 995219

Website : [www.mobilvetta.it](http://www.mobilvetta.it)

---